



DEPARTMENT OF COMMUNITY DEVELOPMENT SERVICES

Planning Division

m e m o r a n d u m

TO: The Urbana Plan Commission

FROM: Jeff Engstrom, AICP, Planner II

DATE: December 13, 2013

SUBJECT: Plan Case 2220-S-13, Request for waiver of Section 21-42.B of the Urbana Subdivision and Land Development Code regarding storm water management requirements for Country Side Second Subdivision

Introduction and Background

Marcus Harris has submitted a petition for a waiver from the storm water management requirements of the Urbana Subdivision and Land Development Code (Section 21-42.B) for the Country Side Second Subdivision. Section 21-42.B.1.a of the Code requires that a storm water management plan be submitted for all residential developments over five acres in area, and the area of Country Side Second Subdivision is 8.38 acres. Section 21-42.B.5.b specifies that for a required storm water management plan, the storm water runoff release rate after development for a 50-year rain event shall not exceed the five-year event release rate of the site prior to development. Waiving the requirement to comply with Section 21-42-B.1.a would remove the requirement to comply with Section 21-42.B.5.b.

The Urbana City Council adopted Ordinance No. 2013-06-053 on June 17, 2013, approving the preliminary and final subdivision plats for the Country Side Second Subdivision. (See Exhibit C) Approval of the plats were conditioned upon a storm water management plan being submitted and approved by the City Engineer. The ordinance approving the plats granted a waiver to allow a 28-foot wide street instead of the required 31-foot wide street, and also granted a deferral to allow construction of sidewalks along Anthony Drive and Cottonwood Road to be delayed until adjacent sidewalk connections become available. The approval of the final plat will expire on December 27, 2013, but a request has been submitted to City Council to extend approval for an additional 180 days.

The final plat for the Country Side Second Subdivision encompasses 8.38 acres to be divided into seven large rural-residential lots and a new public street. The property is located immediately northeast of the intersection of Anthony Drive and Cottonwood Road, approximate one mile from city limits. (See Exhibit A). The subject site contains one house along Anthony Drive, a wooded area along the eastern portion, and the rest of the site is used for agriculture.

Discussion

The petitioner is requesting a waiver from the storm water management requirements of Section 21-42.B of the Urbana Subdivision and Land Development Code. The Code requires that for a residential subdivision over five acres a storm water management plan must be submitted and approved by the City Engineer. The Code further requires that the storm water management plan reduce the amount of runoff from a 50-year rain event so that it does not exceed the pre-development runoff for a five-year rain event. The storm water management plan must include calculations of how much runoff there would be from a five-year rain event (which is the largest rainstorm that is statistically probable to occur in a five-year period). This level is compared to the post-development runoff amount from a 50-year rain event (the largest rainstorm that is likely to occur in a 50-year period). In order to meet this requirement most developments will capture storm water into a detention basin or retention pond and then release it into the storm water sewer system at a controlled rate.

The petitioner predicts that development of Country Side Second Subdivision will result in approximately 1.16 acres of impervious surfaces, including roofs, sidewalks, driveways, and a new street. The petitioner notes that this is lower than the amount of impervious surface that would trigger a requirement for a storm water management plan if the site were less than five acres total. Because the site is over five acres (8.38 acres total), a storm water management plan is required. For a hypothetical site up to five acres in total area, with an impervious area of almost 2.5 acres, a storm water management plan is not required by the Subdivision Ordinance.

Staff's opinion is that there will be no decrease in the stormwater volume from predevelopment to post development conditions. Using published runoff curve numbers the pre-development agricultural runoff curve number is estimated at 0.30. The post development residential condition runoff curve number is estimated at 0.40. A higher runoff curve number results in an increase in stormwater runoff volume.

According to Section 21-7 of the Urbana Subdivision and Land Development Code, the petitioner must justify the granting of a waiver from strict compliance with the Code by showing that the waiver meets certain criteria. These criteria are identified and discussed below:

- 1. There are conditions of topography or other site specific reasons that make the application of any particular requirement of the land development code unnecessary or, in some cases perhaps, even useless;*

One of the unique features of this site is its location. It is within 600 feet of the Saline Branch drainage ditch, and discharges into the drainage ditch four and a half miles downstream from

where the Boneyard Creek ends near downtown Urbana. The petitioner argues that it is better not to delay storm water discharge from this site. Allowing storm water to discharge from the site, instead of capturing it on site and discharging it over time, will decrease peak flows in the Saline. If storm water is captured and released over a longer time, it will contribute to higher levels of flow as the water from Urbana makes its way past the site. If it is discharged before the peak flow from Urbana makes its way to the site, the peak flow will not be increased as much.

Another factor is the nearby Illinois Department of Transportation (IDOT) right-of-way for Interstate 74, which is approximately 630 feet south of the site. Storm water from I-74 drains north to the Saline Branch through two storm sewers. Country Side Second Subdivision drains into one of these storm sewers. A longer discharge time could interfere with drainage from I-74. The applicant's documentation provides a detailed technical analysis of the potential impacts on the IDOT storm sewer.

The stormwater calculations submitted by the petitioner's engineer show that the existing storm sewer does not have sufficient capacity for the five year post development storm event under gravity flow conditions. Staff's opinion is that there is not adequate storm sewer or ditch capacity to convey the five or 50 year design storm peak flows to the Saline Branch so the petitioner's request for waiver of stormwater detention requirements to allow the peak flows to reach the Saline more quickly are not valid. The existing ditches and storm sewer do not have the capacity to carry the peak flows from the site.

Finally, the proposed waivers would allow for development of the subdivision as approved, which would provide better access to the site. The site was subdivided into seven small frontage lots and an inner agricultural lot in 1962. This former plat provides substandard lots, all of which take access directly from Anthony Drive and Cottonwood Road (as shown in Exhibit A). Country Side Second Subdivision corrected these access issues by providing a residential street off of Cottonwood Road instead of multiple driveways. Staff concurs with this factor.

2. The granting of the requested waiver would not harm other nearby properties;

The granting of the waiver to the Subdivision and Land Development Code will not have a negative impact on nearby properties. The petitioner's calculations show that overall runoff will likely decrease by three percent due to the development of the site from agriculture into residential homes with lawns. The development will also decrease "first flush" runoff by eight percent. First flush runoff is the initial surface runoff from a site that washes substances such as dust, organic materials, fertilizers and pesticides off of the site and into the storm water system.

Staff disagrees with the claim of reduction in stormwater runoff volume. The conversion of agricultural land into single family residential development has typically increased the amount of water pollution over the existing agricultural use in stormwater runoff.

3. The waiver would not negatively impact the public health, safety and welfare, including the objectives and goals set forth in the comprehensive plan.

The granting of the requested waiver would not cause any harm to the public health, safety and welfare of the community and would not be contrary to the objectives and goals set forth in the Comprehensive Plan. The applicant states that failure to grant the proposed waiver could negatively impact the public welfare because it will delay peak flows from the site to coincide with peak flows from the IDOT I-74 sewer. Staff does not agree with the applicant's claim because capacity issues with the existing ditches and storm sewer result in the inability to convey peak flows down the storm sewer.

However, granting the waiver would allow for development of the site in a manner that conforms to the City's adopted access management guides, with safer access from Cottonwood Road. The Urbana Comprehensive Plan shows the future land use for this area as rural residential; granting the requested waiver would allow for development as such.

Summary of Staff Findings

1. The Urbana City Council adopted Ordinance No. 2013-06-053 on June 17, 2013, approving the preliminary and final subdivision plats for the Country Side Second Subdivision.
2. The petitioner is requesting an extension of the approval of the final plat, which will be considered by the City Council along with this waiver request.
3. The petitioner is requesting a waiver from the storm water management plan requirements of the Urbana Subdivision and Land Development Code (Sections 21-42.B.1.a and 21-42.B.5.b) for the Subdivision.
4. The petitioner claims the requested waiver is necessary because delaying storm water release from the site could interfere with drainage from Interstate 74. Staff analysis does not support the petitioner's claim.
5. The proposed waiver would allow for development of the site in line with the City's access management guidelines.
6. The requested waiver will not be harmful to other properties and would not negatively impact the public health, safety and welfare of the community, nor impede the attainment of goals and objectives contained in the Comprehensive Plan.

Options

The Urbana Plan Commission has the following options regarding Plan Case 2220-S-13:

- a. forward the case to City Council with a recommendation for approval of the requested waiver of the storm water management plan requirements of the Urbana Subdivision and Land Development Code; or

- b. forward the case to City Council with a recommendation for denial of the requested waiver of the storm water management plan requirements of the Urbana Subdivision and Land Development Code.

Staff Recommendation

Staff recommends that the Urbana Plan Commission forward this case to the City Council with a recommendation for either approval or denial of the requested waiver from the storm water management plan requirements of Sections 21-42.B.1.a and 21-42.B.5.b of the Urbana Subdivision and Land Development Code.

Attachments: Exhibit A: Location Map
Exhibit B: Petition for Waiver of Subdivision Regulations
Exhibit C: Approved Preliminary and Final Plat for Country Side Second
Subdivision

cc: Marcus Harris
1780 County Rd 1650 North
Urbana, IL 61802

Roger Meyer
Berns, Clancy and Associates
P.O. Box 755
Urbana, IL 61803-0755

Exhibit A: Location and Existing Land Use Map



Case: 2220-S-13
Subject: Countryside Second Subdivision
Waiver Request
Location: Cottonwood Rd & Anthony Dr
Petitioner: Marcus Harris

 Subject Property



**Application for a Waiver of
the Subdivision Regulations**

**Plan
Commission**

DO NOT WRITE IN THIS SPACE - FOR OFFICE USE ONLY

Date Request Filed: 12/11/13 Plan Case No.: 2220-S-13

PLEASE PRINT OR TYPE THE FOLLOWING INFORMATION

1. APPLICANT CONTACT INFORMATION

Name of Applicant(s): **MARCUS HARRIS** Phone: **217-621-3971**
 Address (street/city/state/zip code): **1780 COUNTY ROAD 1650 NORTH, URBANA, IL 61802**
 Email Address: **MHARRISJ4@AOL.COM**
 Property interest of Applicant(s) (Owner, Contract Buyer, etc.): **OWNER**

2. OWNER INFORMATION

Name of Owner(s): **MARCUS HARRIS** Phone: **217-621-3971**
 Address (street/city/state/zip code): **1780 COUNTY ROAD 1650 NORTH, URBANA, IL 61802**
 Email Address: **MHARRISJ4@AOL.COM**
 Is this property owned by a Land Trust? Yes No
 If yes, please attach a list of all individuals holding an interest in said Trust.

3. PROPERTY INFORMATION

Name of Development: **COUNTRY SIDE SECOND SUBDIVISION**
 Address/Location of Subject Site:
 PIN # of Location: **SEE EXHIBIT A**
 Legal Description: **SEE EXHIBIT A**

Waiver(s) Requested: **SECTION 21-42 - STORMWATER MANAGEMENT**
SECTION (B)(1)B. RESIDENTIAL DEVELOPMENTS OF FIVE (5) ACRES OR
MORE, AND SECTION (B)(5)B. STORMWATER RELEASE RATE SHALL NOT

EXCEED THE RELEASE RATE OF A FIVE YEAR EVENT PRIOR TO DEVELOPMENT.

Section: _____ Subsection: _____ Page: _____

Section: _____ Subsection: _____ Page: _____

Section: _____ Subsection: _____ Page: _____

What practical difficulties or conditions exist that are not applicable generally to other properties which make it difficult to comply with the requirements of the development ordinance?

Construction of a small stormwater detention basin on a large lot rural subdivision is generally impractical and generally unnecessary.

What effects will the requested waiver(s) have on present and future public services to the property proposed for subdivision and lands adjacent to the property? Further, will such waiver(s) result in any negative impact or environmental incursions to the property adjacent to or in the vicinity of the proposed subdivision? If so, please state (or attach) evidence identifying such impacts and proposed solutions in order to mitigate or reduce the negative impacts resulting from the waiver(s).

NONE

What other circumstances justify granting the requested waiver(s)? **SECTION (B)(1)A. ALLOWS AN EXEMPTION FOR RESIDENTIAL DEVELOPMENTS LESS THAN FIVE ACRES WITH LESS THAN 50% IMPERVIOUS SURFACE. (LESS THAN 2.5 ACRES ON A 5 ACRE SITE) THE PROPOSED DEVELOPMENT IS APPROXIMATELY 8.38 ACRES WITH APPROXIAMTELY 1.16 ACRES OF IMPERVIOUS SURFACE. (LESS THAN 14% IMPERVIOUS SURFACE AND LESS THAN HALF OF THE IMPERVIOUS SURFACE ALLOWABLE BY SECTION**

(B)(1)A FOR A 5 ACRE SITE.) STORMWATER RUNOFF CALCULATIONS INDICATE STORMWATER RUNOFF WILL LIKELY DECREASE 3% DUE TO THE PROPOSED DEVELOPMENT AND "FIRST FLUSH" STORMWATER RUNOFF WILL LIKELY DECREASE 8% DUE TO THE PROPOSED DEVELOPMENT. THEREFORE, A REQUEST FOR A WAIVER FROM THE STORMWATER DETENTION REQUIREMENT IS REASONABLE.

Additional exhibits submitted by the petitioner: **STORMWATER MANAGEMENT REPORT, DATED JULY 23, 2013, FOR SUBJECT SITE.**

NOTE: If additional space is needed to accurately answer any question, please attach extra pages to the application.

CERTIFICATION BY THE APPLICANT

I certify all the information contained in this application form or any attachment(s), document(s) or plan(s) submitted herewith are true to the best of my knowledge and belief, and that I am either the property owner or authorized to make this application on the owner's behalf.

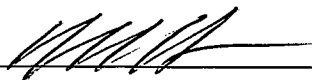

Applicant's Signature

10/20/2013
Date



BERNS, CLANCY AND ASSOCIATES

PROFESSIONAL CORPORATION

ENGINEERS • SURVEYORS • PLANNERS

December 11, 2013

EXHIBIT B

THOMAS BERNS
EDWARD CLANCY
CHRISTOPHER BILLING
DONALD WAUTHIER
GREGORY GUSTAFSON

ROGER MEYER
DAN ROTHERMEL
KATHERINE LATHAM

MICHAEL BERNS
OF COUNSEL

Stormwater Detention Basin Waiver Request

Country Side Second Subdivision is located on the eastern side of Cottonwood Road and the northern side of Anthony Drive approximately 1 mile northeasterly of the current City of Urbana Corporate Limits. Anthony Drive is located approximately 700 feet northerly of Interstate 74 and approximately 1,200 feet southerly of the Saline Branch Drainage Ditch (see attached exhibits).

There are four (4) small drainage areas within **Country Side Second Subdivision**. See attached drawing.

Drainage Area 1 is located northerly of the proposed Dolder Court roadway and extends east-northeasterly into the wooded area on the eastern side of **Country Side Second Subdivision**. **Drainage Area 1** surface drains northerly and / or northwesterly to adjoining property and / or to Cottonwood Road right-of-way and thence to the Saline Branch Drainage Ditch. Stormwater runoff from **Drainage Area 1** does not flow to the existing field tile on the eastern side of Cottonwood Road. Therefore it is not included in our analysis of the existing field tile.

Drainage Area 2 is located near the middle of **Country Side Second Subdivision** and drains to the proposed **Country Side Second Subdivision** storm sewer system and then to the existing field tile on the eastern side of Cottonwood Road. Our stormwater calculations for this existing field tile indicate a stormwater runoff rate of 8.0 cfs for a 5 year rainfall event and a stormwater runoff rate of 12.7 cfs for a 50 year rainfall event. Our storm sewer analysis indicates the existing field tile will accommodate a 5 year rainfall event with approximately 6.5 feet of head (surcharge) at the Dolder Court storm sewer connection point. Our storm sewer analysis indicates the existing field tile may accommodate a 10 year rainfall event and that larger rainfall events may result in surface water near the proposed inlets on Dolder Court. The Construction Plans provide for an emergency overflow northerly and then northwesterly to limit potential flooding of Dolder Court pavement. We anticipate approximately 6 ½ to 7 inches of stormwater flooding may occur at the proposed inlets and approximately 3 inches of stormwater flooding may occur at the centerline of Dolder Court during significant rainfall events.

Bulletin 70 indicates the rainfall intensity for a 100 year event and a 60 minute time of concentration is the same as a 10 year event and a 30 minute time of concentration. Therefore we anticipate the period of flooding will be relatively short during significant rainfall events and that the shallow 3 inch depth of stormwater along the centerline of Dolder Court will not produce a hardship for the four (4) homes proposed along Dolder Court.

Stormwater Detention Basin Waiver Request
Country Side Second Subdivision
Urbana Township, Champaign County, Illinois
November 29, 2013
Page 2 of 4

Drainage Area 3 is a wooded area located on the eastern side of **Country Side Second Subdivision** which drains easterly to adjacent wooded property.

Drainage Area 4 is located along Anthony Drive. **Drainage Area 4** surface drains to existing road ditches and then flows northerly to the Saline Branch Drainage Ditch. Stormwater runoff from **Drainage Area 4** does not flow to the existing field tile on the eastern side of Cottonwood Road. Therefore it is not included in our analysis of the existing field tile.

An existing 15 inch diameter field tile is located along the eastern side of Cottonwood Road with a manhole near the road shoulder approximately 55 feet northerly of Anthony Drive. Illinois Department of Transportation (IDOT) constructed said manhole and a 15 inch diameter storm sewer southwesterly across the Cottonwood Road / Anthony Drive intersection and thence southerly along the Cottonwood Road right-of-way to allow IDOT to abandon a field tile located under the Interstate 74 overpass. IDOT Plans, dated 1956, indicate an open inlet approximately 1,800 feet upstream (southerly) of the manhole on the northern side of Anthony Drive. This open inlet is located in the bottom of the road ditch in a low area at the southern end of the Interstate 74 overpass. A pre-existing 14 inch diameter field tile extends southerly from this open inlet. See attached photos.

IDOT also constructed a ditch along the western Cottonwood Road right-of-way with culverts under both Interstate 74 roadways and also under Cottonwood Road southerly of Anthony Drive. Except for the area draining to the open inlet south of Interstate 74, all areas draining to Cottonwood Road right-of-way southerly of Anthony Drive drain to the western side of Cottonwood Road and thence drain northerly on the western side of Cottonwood Road to the Saline Branch Drainage Ditch or drain southerly to US Route 150 right of way and DO NOT impact drainage on **Country Side Second Subdivision**.

IDOT records do not show the areas served by the 14 inch diameter farm tile. IDOT records DO NOT include a stormwater runoff analysis for the IDOT storm sewer. However, the initial time of concentration for a 14 inch diameter farm tile is likely greater than 60 minutes and may be significantly more.

Jim Prather, Urbana Township Road District Commissioner, reports no drainage problems at the location of this open inlet. Jim reported drainage problems further south near U.S. Route 150.

Our survey data indicates 6.7 feet of fall in the existing IDOT 1,800 foot long storm sewer system. Storm sewer analysis indicates an average pipe slope of 0.37%, and a storm sewer capacity of approximately 4 cubic foot per second (CFS) and stormwater flow rate of 3.6 feet per second (FPS) under gravity conditions.

Our survey data indicates 1.6 feet of fall in the existing 699 foot long field tile located westerly of **Country Side Second Subdivision** on the eastern side of Cottonwood Road. Storm sewer analysis indicates an average pipe slope of 0.22% and a storm sewer capacity of approximately 3 cfs and a stormwater flow rate of 2.8 FPS under gravity conditions.

The IDOT Plans indicate a storm sewer system length of 1,800 feet. The IDOT manhole northerly of Anthony Drive is approximately 300 feet southerly of the proposed **Country Side Second Subdivision** storm sewer. There are no open manholes or inlets along this storm sewer system. Therefore, we utilized a total length of 2,100 feet for the IDOT storm sewer system. Assuming an average velocity of 4 FSP the IDOT storm sewer system travel time is approximately 9 minutes.

For our calculations we utilized an initial time of concentration of 60 minutes for the 14 inch farm tile and a storm sewer travel time of 10 minutes for the IDOT storm sewer system for a total time of concentration of 70 minutes.

The rainfall intensity for a 70 minute, 50 year event is 2.6 inches per hour which calculates to a 7.5 CFS flow rate from **Country Side Second Subdivision**.

Our Stormwater Management Report, dated July 23, 2013 indicates a pre-development time of concentration of 30 minutes an allowable 5 year event flow rate of 8.3 CFS for the Country Side Second Subdivision. Copy attached.

Therefore the flow rate from the **Country Side Second Subdivision** storm sewer is less than the pre-development allowable flow rate of 8.3 CFS at the peak IDOT storm sewer flow rate.

Prior experience with stormwater detention basins for small developments indicates a probable peak detention basin volume within a 60 minute to 90 minute time interval.

Our analysis indicates that the stormwater runoff rate from **Country Side Second Subdivision** storm sewer will likely be decreasing while the stormwater runoff rate from the IDOT storm sewer system will be increasing.

Construction of a stormwater detention basin at **Country Side Second Subdivision** will detain stormwater runoff and will likely result in a flow rate from **Country Side Second Subdivision** storm sewer which is near the allowable 8.3 CFS coincident with the peak flow rate from the IDOT storm sewer system.

Stormwater Detention Basin Waiver Request**Country Side Second Subdivision**

Urbana Township, Champaign County, Illinois

November 29, 2013

Page 4 of 4

We believe that a storm water detention basin at subject site will likely increase the peak flow rate in the existing field tile northerly of **Country Side Second Subdivision**.

We believe that construction of a storm water detention basin at **Country Side Second Subdivision** will NOT help to protect the public and may result in harm to the public. We therefore request a waiver from stormwater detention on subject site.

The existing road ditches along the eastern side of Cottonwood Road and the northern side of Anthony Drive are currently relatively shallow. A culvert is currently located on the northern side of Anthony Drive approximately 220 feet easterly of Cottonwood Road. Our proposed Construction Plans provide for removal of this existing culvert and grading a new ditch from the existing house on proposed Lot 16 westerly along the northern side of Anthony Drive and thence northerly along the eastern side of Cottonwood Road to an existing culvert on the western side of Lot 1 of Country Side Subdivision. We submitted our "Preliminary" Construction Plans to Jim Prather, Urbana Township Road District Commissioner for review. Jim Prather indicated verbally that he has no objections to our "Preliminary" Construction Plans, however, we have not yet received his written response.

Countryside Second Subdivision
Part of the Southwest Quarter of the Northwest Quarter of
Section 12, Township 19 North, Range 9 East of the Third P.M.
Urbana Township, Champaign County, Illinois
December 6, 2013

Proposed Drainage Area 2

	area acres	"c" factor
Wooded - average slope	1.09	0.34
Grass / Landscape - flat slope	2.74	0.23
Impervious - flat slope	<u>0.75</u>	<u>0.90</u>
Proposed Site	4.58	0.37

Initial Time (Ti)

Distance	150 Feet
Manning's n	0.40 (Woods)
P 2 year, 24 hour	3.1
Slope	2.9% Slope
Ti	26 minutes

Travel Time (Tt)

Distance	500 Feet
Slope	1.1% Slope
Velocity	1.7 FPS
Tt	5 minutes

Time of Concentration (Tc)

31 minutes

Rainfall Intensity at 30 minute Tc

Storm Event	Rainfall Intensity in / hr	Peak Runoff Rate CFS
1 year	1.82	5.34
2 year	2.22	6.51
5 year	2.74	8.04
10 year	3.14	9.21
25 year	3.74	10.97
50 year	4.32	12.67
100 year	4.90	14.37

Countryside Second Subdivision
Part of the Southwest Quarter of the Northwest Quarter of
Section 12, Township 19 North, Range 9 East of the Third P.M.
Urbana Township, Champaign County, Illinois
December 6, 2013

Proposed Site

	area acres	"c" factor
Wooded - average slope	1.90	0.34
Grass / Landscape - flat slope	-2.31	0.23
Impervious - flat slope	<u>1.16</u>	<u>0.90</u>
Proposed Site	0.75	1.54

Time of Concentration (T_c) 70 minutes

Rainfall Intensity at 70 minute T_c

Storm Event	Rainfall Intensity in / hr	Peak Runoff Rate CFS
1 year	1.09	3.19
2 year	1.32	3.88
5 year	1.63	4.79
10 year	1.88	5.50
25 year	2.24	6.57
50 year	2.57	7.54
100 year	2.92	8.55



BERNS, CLANCY AND ASSOCIATES

PROFESSIONAL CORPORATION

ENGINEERS • SURVEYORS • PLANNERS

July 23, 2013

EXHIBIT B

THOMAS BERNS
EDWARD CLANCY
CHRISTOPHER BILLING
DONALD WAUTHIER
GREGORY GUSTAFSON

ROGER MEYER
DAN ROTHERMEL
KATHERINE LATHAM

MICHAEL BERNS
OF COUNSEL

**STORMWATER MANAGEMENT REPORT
COUNTRYSIDE SECOND SUBDIVISION
PART OF THE SOUTHWEST QUARTER OF THE
NORTHWEST QUARTER OF SECTION 12,
TOWNSHIP 19 NORTH,
RANGE 9 EAST OF THE THIRD PRINCIPAL MERIDIAN,
URBANA TOWNSHIP, CHAMPAIGN COUNTY, ILLINOIS**

The proposed **Countryside Second Subdivision** is an 8.38± acre site located easterly of Cottonwood Road and northerly of Anthony Drive in Urbana Township. Subject site was previously subdivided in 1962 into seven (7) small 0.4± acre lots and a 5½± acre remainder parcel currently with a single family residence located on existing Lot 7. See attached Countryside Subdivision Plat.

Subject site encompasses approximately 1.9± acres of woods along the eastern side; approximately 0.5± acres of grass, woods and landscaping on the northern side; approximately 0.7± acres of grass, trees, landscape, driveway and building; and approximately 5.3± acres of current farm tillage area.

Approximately ½ acre of wooded area easterly of the subject site drains westerly onto and across subject site. All other adjacent areas drain northerly to the Saline Branch Drainage Ditch or drain to existing road side ditches and an existing 15 inch diameter storm sewer and then drain northerly to the Saline Branch Drainage Ditch.

A 260 foot long cul-de-sac street is proposed southerly of proposed Lot 11 to serve the proposed four (4) northern lots. A short storm sewer system is proposed to provide drainage of the proposed street pavement to an existing 15 inch diameter storm sewer system located on the western side of Cottonwood Road. An emergency overflow swale is proposed northerly and northwesterly from the street low point to limit local street flooding during significant rainfall events or in the event of storm sewer failure. A 5 foot wide sidewalk is proposed along the right-of-way lines of this proposed cul-de-sac street. See attached Country Side Second Subdivision Preliminary Plat.

The flow path for stormwater runoff will likely remain unchanged, except for areas adjacent to the proposed new street. Therefore the overall Time of Concentration will likely remain unchanged. Our calculations indicate a time of concentration of approximately 30 minutes. See attached calculations.

6598

For stormwater management purposes we compared the proposed site to an anticipated pre-1962 subdivision approval site. We assume the pre-1962 site was agricultural row crop tillage with woods along the eastern side. We assumed that the wooded area was the same as the current wooded area. We also assumed a maximum of 3,000 square feet of roof area and a maximum of 2,000 square feet of driveways will be built on each proposed lot for a total of 5,000 square feet per lot. For reference the existing residence on proposed Lot 16 is 2,730 square feet and the existing driveway is 1,100 square feet for a total of 3,840 square feet of impervious surface on proposed Lot 16.

We anticipate a maximum of 35,000 square feet of new impervious surface for residential development. Dolder Circle street and sidewalk construction will create approximately 15,700 square feet of new impervious surface. Maximum anticipated surface is therefore 50,700 square feet or 1.16 ± acres.

Our stormwater calculations indicate stormwater runoff will likely decrease approximately 3% due to the development of Country Side Second Subdivision.

We anticipate most new impervious surface will be placed within 130 feet of the right-of-way or within 130 feet of Dolder Circle pavement. Therefore, we also calculated the expected "first flush" stormwater runoff for the "developed" area. We calculated a "first flush" time of concentration of 20 minutes for this proposed "first flush" drainage area. We calculated a "first flush" time of concentration of 15 minutes for this "first flush" drainage area under pre-1962 agricultural row crop conditions. See attached Stormwater Management Exhibit.

Our stormwater calculations indicated stormwater for this proposed "first flush" drainage area will decrease approximately 8% due to the development of Country Side Second Subdivision.

Our calculations indicate development of Country Side Second Subdivision will likely decrease the stormwater runoff rate from subject site.

Countryside Second Subdivision
Part of the Southwest Quarter of the Northwest Quarter of
Section 12, Township 19 North, Range 9 East of the Third P.M.
Urbana Township, Champaign County, Illinois
July 23, 2013

Pre-1962 Site

	area acres	"c" factor
Wooded - average slope	1.90	0.34
Cultivation - flat slope	6.48	0.37
Existing Site	8.38	0.36

Initial Time (Ti)

Distance	150 Feet
Manning's n	0.40 (Woods)
P 2 year, 24 hour	3.1
Slope	2.9% Slope
Ti	26 minutes

Travel Time (Tt)

	500 Feet
	1.1% Slope
Velocity	1.7 FPS
Tt	5 minutes

Time of Concentration (Tc) 31 minutes

Rainfall Intensity at 30 minute Tc

Storm Event	Rainfall Intensity in / hr	Peak Runoff Rate CFS
1 year	1.82	5.49
2 year	2.22	6.70
5 year	2.74	8.27
10 year	3.14	9.47
25 year	3.74	11.28
50 year	4.32	13.03
100 year	4.90	14.78

Countryside Second Subdivision
Part of the Southwest Quarter of the Northwest Quarter of
Section 12, Township 19 North, Range 9 East of the Third P.M.
Urbana Township, Champaign County, Illinois
July 23, 2013

Proposed Site

	area acres	"c" factor
Wooded - average slope	1.90	0.34
Grass / Landscape - flat slope	5.32	0.23
Impervious - flat slope	<u>1.16</u>	<u>0.90</u>
Proposed Site	8.38	0.35

Initial Time (Ti)

Distance	150 Feet
Manning's n	0.40 (Woods)
P 2 year, 24 hour	3.1
Slope	2.9% Slope
Ti	26 minutes

Travel Time (Tt)

Velocity	500 Feet
Tt	1.1% Slope
	1.7 FPS
	5 minutes

Time of Concentration (Tc) 31 minutes

Rainfall Intensity at 30 minute Tc

Storm Event	Rainfall Intensity in / hr	Peak Runoff Rate CFS
1 year	1.82	5.34
2 year	2.22	6.51
5 year	2.74	8.04
10 year	3.14	9.21
25 year	3.74	10.97
50 year	4.32	12.67
100 year	4.90	14.37

Countryside Second Subdivision
Part of the Southwest Quarter of the Northwest Quarter of
Section 12, Township 19 North, Range 9 East of the Third P.M.
Urbana Township, Champaign County, Illinois
July 23, 2013

Pre-1962 site - within 130 feet from proposed pavement or right-of-way line

	area	"c"
	acres	factor
Cultivation - flat slope	5.09	0.37

Initial Time (Ti)	
Distance	130 Feet
Manning's n	0.15 cultivated
P 2 year, 24 hour	3.1
Slope	1.0% Slope
Ti	16 minutes

Time of Concentration (Tc)	15 minutes
----------------------------	------------

Rainfall Intensity at 10 minute Tc

Storm Event	Rainfall Intensity in / hr	Peak Runoff Rate CFS
1 year	2.65	4.99
2 year	3.24	6.10
5 year	4.00	7.53
10 year	4.56	8.59
25 year	5.48	10.32
50 year	6.40	12.05
100 year	7.40	13.94

Countryside Second Subdivision
Part of the Southwest Quarter of the Northwest Quarter of
Section 12, Township 19 North, Range 9 East of the Third P.M.
Urbana Township, Champaign County, Illinois
July 23, 2013

Proposed Site - within 130 feet from pavement or right-of-way line.

	area acres	"c" factor
Grass / Landscape - flat slope	3.93	0.23
Impervious - flat slope	<u>1.16</u>	<u>0.90</u>
Proposed Site	5.09	0.38

Initial Time (Ti)	
Distance	130 Feet
Manning's n	0.20 grass
P 2year, 24 hour	3.1
Slope	1.0% Slope
Ti	20 minutes

Time of Concentration (T_c) 20 minutes

Rainfall Intensity at 10 minute T_c

Storm Event	Rainfall Intensity in / hr	Peak Runoff Rate CFS
1 year	2.37	4.58
2 year	2.90	5.61
5 year	3.58	6.92
10 year	4.09	7.91
25 year	4.90	9.48
50 year	5.71	11.04
100 year	6.57	12.71

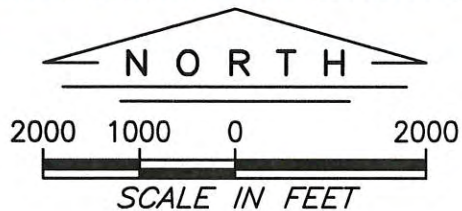
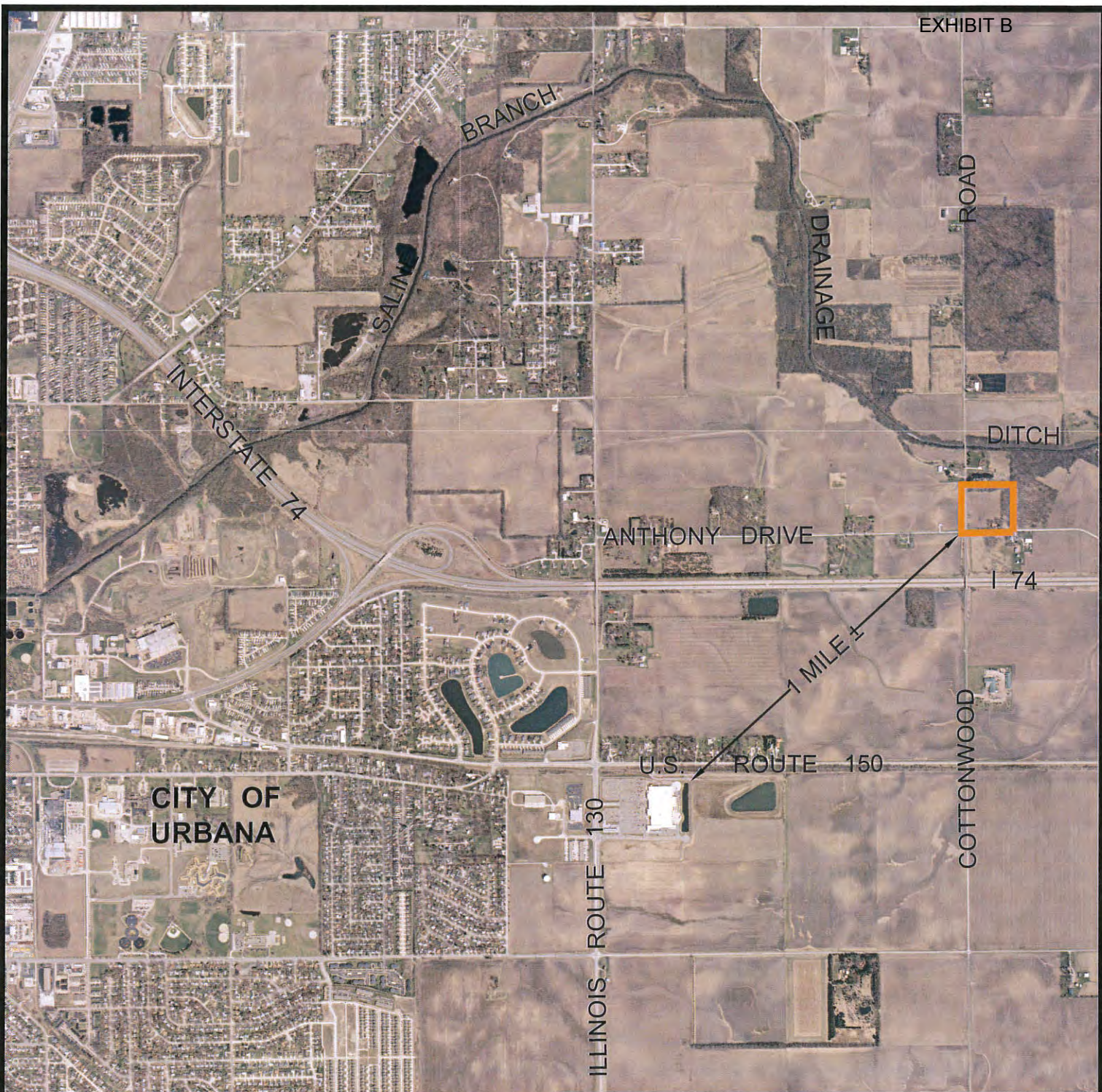

 SUBJECT SITE

CHAMPAIGN COUNTY ORTHOPHOGRAPHY
DATED APRIL 2008

PHOTO LOCATION EXHIBIT

COUNTRYSIDE SECOND SUBDIVISION
URBANA TOWNSHIP,
CHAMPAIGN COUNTY, ILLINOIS



BERNS, CLANCY AND ASSOCIATES
ENGINEERS • SURVEYORS • PLANNERS
405 EAST MAIN STREET - POST OFFICE BOX 755
URBANA, ILLINOIS 61803-0755
PHONE: (217) 384-1144 - FAX: (217) 384-3355

SHEET 1 OF 1

DATE: 121113

JOB: 6598

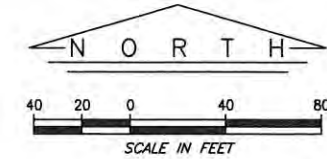

- LEGEND**
- 30 INCH LONG, 1/2 INCH DIAMETER IRON PIPE SURVEY MONUMENT SET WITH ALUMINUM CAP STAMPED "ILS 2006 2207"
 - EXISTING IRON PIPE/PIN SURVEY MONUMENT FOUND
 - ⊠ EXISTING CONCRETE MARKER FOUND
 - () RECORD MEASUREMENT AND/OR DATA
 - WC: WITNESS CORNER
 - ⊥ DENOTES 90 DEGREE ANGLE
 - EXISTING DITCH CENTERLINE
 - *— EXISTING FENCE LINE
 - - - EXISTING UTILITY EASEMENT LINE
 - |— EXISTING CENTERLINE
 - |— EXISTING BUILDING SETBACK LINE
 - - - EXISTING RIGHT-OF-WAY
 - - - PROPOSED RIGHT-OF-WAY
 - - - PROPOSED BUILDING SETBACK LINE
 - - - PROPOSED UTILITY EASEMENT LINE
 - - - PROPOSED SANITARY EASEMENT LINE
 - |— PROPOSED STREET CENTERLINE
 - - - PROPOSED EMERGENCY DRAINAGE SWALE
 - |— TITLE LINE
 - /// EXISTING BUILDING LINE
 - |— EXISTING CULVERT
 - OT- EXISTING OVERHEAD TELEPHONE LINE
 - OE- EXISTING OVERHEAD ELECTRIC LINE
 - AC- VEHICULAR ACCESS CONTROL
 - LOT 17 PROPOSED LOT NUMBER
 - CR LOT WITHIN COUNTY CONSERVATION RECREATION (CR) ZONING DISTRICT
 - AG-2 LOT WITHIN COUNTY AGRICULTURE (AG-2) ZONING DISTRICT
- EXHIBIT B**
- EXISTING SIGN
 - EXISTING POLE/POST
 - BENCHMARK/DESIGNATION
 - TS#1 TRAVERSE STATION
 - ⊙ EXISTING DECIDUOUS TREE/SIZE
 - ⊙ EXISTING EVERGREEN TREE/SIZE
 - ⊙ EXISTING "SOFT" SPOT ELEVATION
 - ⊙ EXISTING "HARD" SPOT ELEVATION
 - ⊙ EXISTING "HARD" SPOT ELEVATION AT MANHOLE RIM
 - ⊙ EXISTING GAS METER
 - ⊙ EXISTING WATER WELL
 - ⊙ EXISTING TELEPHONE PEDESTAL
 - ⊙ EXISTING UTILITY POLE/GUY WIRE/TRANSFORMER
 - ⊙ EXISTING GLOBE POLE LIGHT
 - ⊙ EXISTING STORM SEWER MANHOLE (OPEN LID)
 - ⊙ BERN, CLANCY AND ASSOCIATES MANHOLE DESIGNATION
 - 10"ST- EXISTING STORM SEWER LINE/SIZE (APPROXIMATE LOCATION)
 - ? DESTINATION OR DATA UNKNOWN
 - ⊙ EXISTING PRIVATE MAILBOX
 - ⊙ EXISTING SANITARY SEWER CLEANOUT
 - 700 EXISTING INDEX CONTOUR LINE
 - 698 EXISTING INTERMEDIATE CONTOUR LINE
 - EXISTING CULTIVATION LINE
 - EXISTING TREE LINE
 - △ EXISTING ELECTRIC METER
 - (LOT 8) PRE-EXISTING LOT NUMBER OF COUNTRYSIDE SUBDIVISION OF PLAT BOOK "N" PAGE 106 RECORDED JUNE 11, 1962
 - APPROXIMATE DRAINAGE PERIMETER
 - EXISTING STORM SEWER SYSTEM
 - EXISTING IDOT STORM SEWER FIELD TILE SYSTEM
- SIGNED AND SEALED DECEMBER 11, 2013

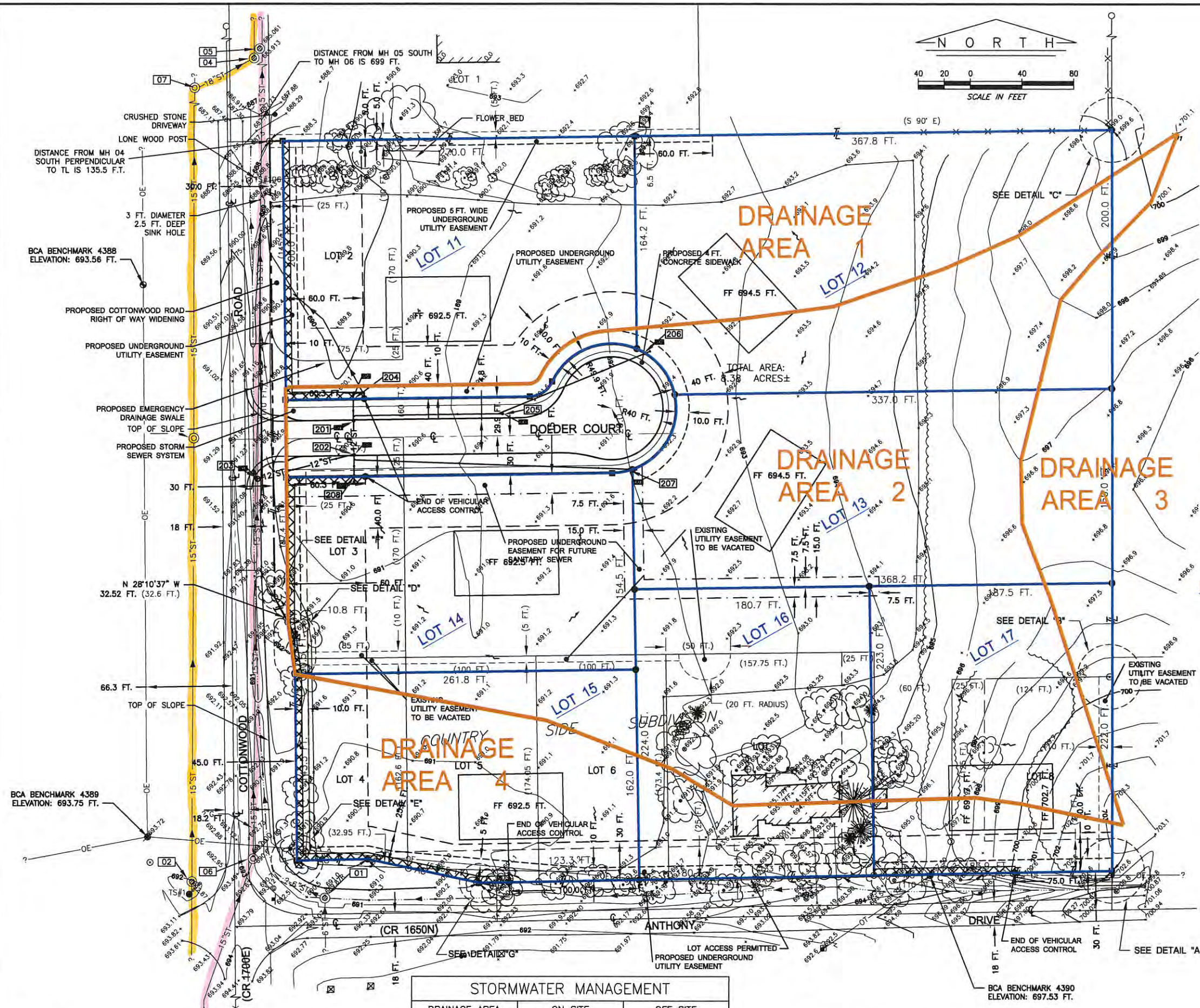

STORMWATER MANAGEMENT		
DRAINAGE AREA	ON SITE	OFF SITE
1	2.05 ACRES	-----
2	4.56 ACRES	.02 ACRES
3	.42 ACRES	-----
4	1.26 ACRES	-----

OWNER / DEVELOPER:
 MARCUS HARRIS
 1780 CR 1650 NORTH
 URBANA IL 61802
 (217) 621-3971

ATTORNEY:
 JASON BARICKMAN
 MEYER CAPEL, A PROFESSIONAL CORPORATION
 306 WEST CHURCH ST
 CHAMPAIGN IL 61820

ROGER D. MEYER, P.E., L.S., PROJECT ENGINEER
 BERN, CLANCY AND ASSOCIATES, P.C.
 ILLINOIS PROFESSIONAL LAND SURVEYOR 3396
 LICENSE EXPIRATION: NOVEMBER 30, 2014
 ILLINOIS PROFESSIONAL ENGINEER 52503
 LICENSE EXPIRATION: NOVEMBER 30, 2015
 URBANA, CHAMPAIGN COUNTY, ILLINOIS
 ILLINOIS PROFESSIONAL DESIGN FIRM 2999
 LICENSE EXPIRATION: APRIL 30, 2015

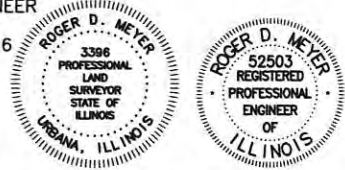

STORMWATER MANAGEMENT PLAN
COUNTRY SIDE SECOND SUBDIVISION,
 URBANA TOWNSHIP,
 CHAMPAIGN COUNTY, ILLINOIS

BCA BERN, CLANCY AND ASSOCIATES
 ENGINEERS • SURVEYORS • PLANNERS
 405 EAST MAIN STREET - POST OFFICE BOX 755
 URBANA, ILLINOIS 61803-0755
 PHONE: (217) 384-1144 - FAX: (217) 384-3355

JOB: 6598 DATE: 121113 SHEET 1 OF 1
 FILE: 6598-1PP.DWG

J. U. L. I. E.
 NOTE: THE EXACT LOCATION OF ALL UTILITIES SHALL BE VERIFIED BY THE CONTRACTOR PRIOR TO CONSTRUCTION ACTIVITIES. FOR UTILITY LOCATIONS CALL: J.U.L.I.E. (800) 892-0123

© 2013 ALL RIGHTS RESERVED
 BERN, CLANCY AND ASSOCIATES, P.C.

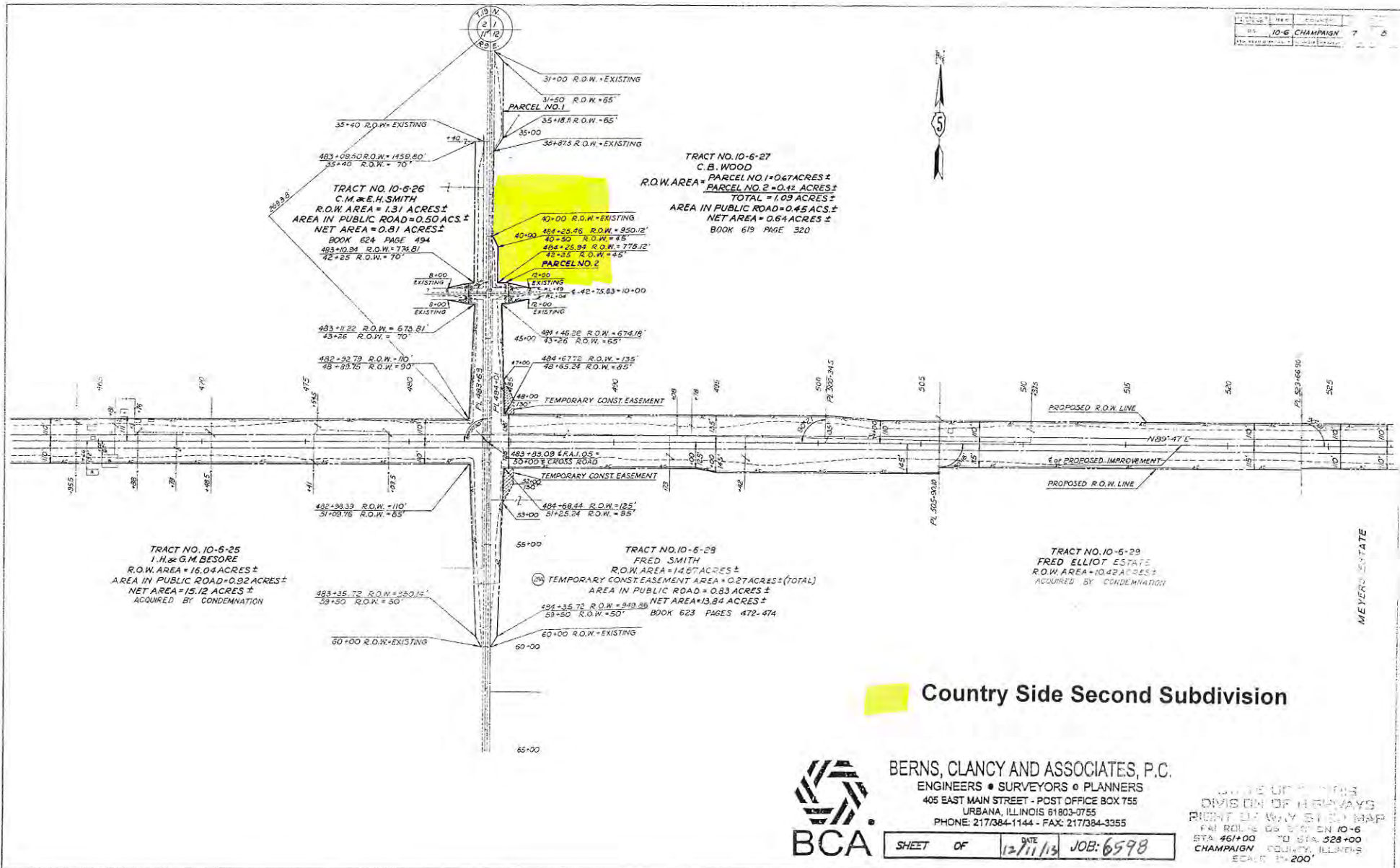

SEC. 12, T. 19N, R. 9E, 3 P.M.

NOTE: EXISTING CULVERT PIPES UNDER DETOUR TO BE SALVAGED BY AND BECOME PROPERTY OF CONTRACTOR FOR SEC. 10-6. SEE SPECIAL PROVISIONS.

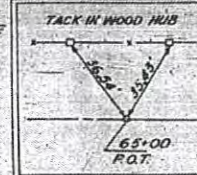

SECTION	DATE	COUNTY	TOTAL SHEETS
SEC. 10-6	10-6	CHAMPAIGN	149
STA. 30+00			TO STA. 65+00
CROSSROAD @ STA. 483+83.09			

Country Side Second Subdivision

DATE	BY	REVISION
10/15/06

PLANNED BY: ...
 SURVEYED BY: ...
 CHECKED BY: ...

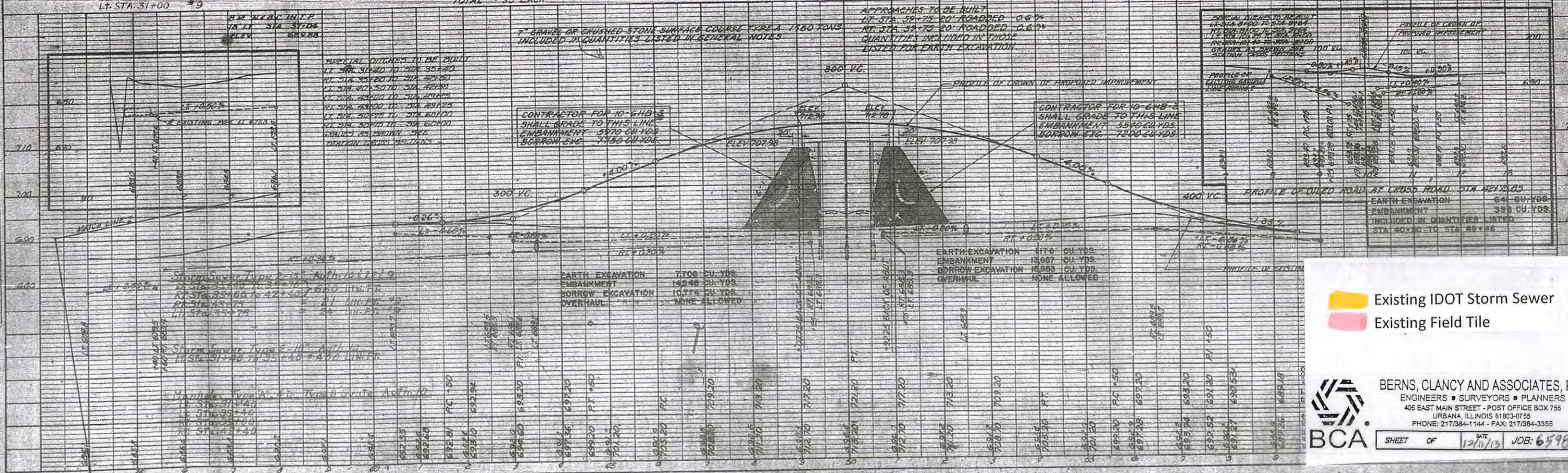
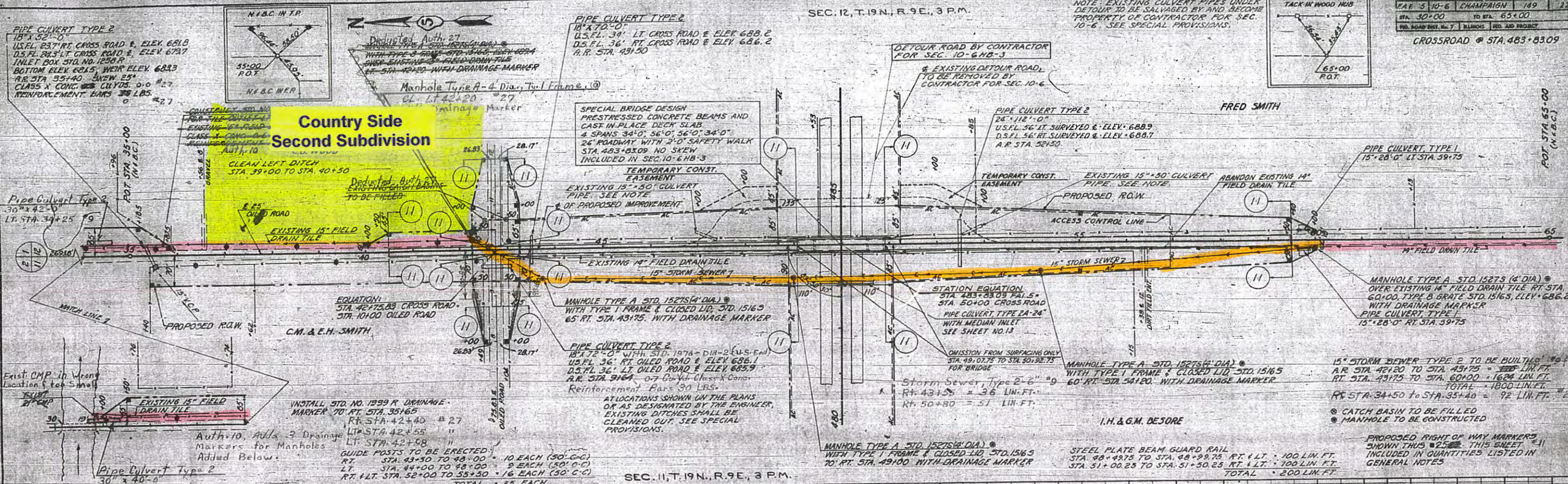

Existing IDOT Storm Sewer
 Existing Field Tile

BCA BERN, CLANCY AND ASSOCIATES, P.C.
 ENGINEERS • SURVEYORS • PLANNERS
 405 EAST MAIN STREET • POST OFFICE BOX 755
 URBANA, ILLINOIS 61803-0755
 PHONE: 217/384-1144 • FAX: 217/384-3355

SHEET OF DATE 12/11/13 JOB: 6598

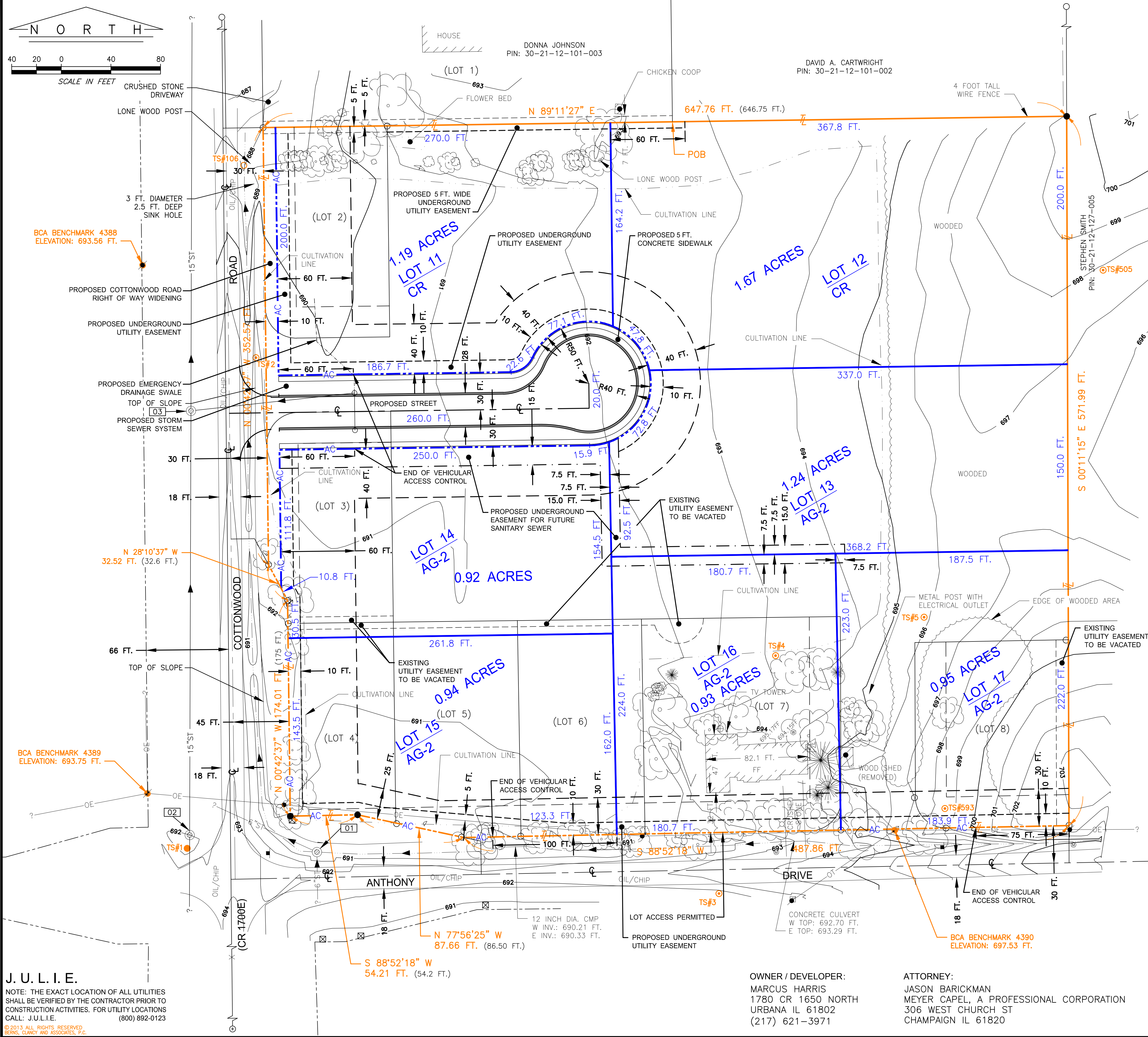

- LEGEND**
- 30 INCH LONG, 1/2 INCH DIAMETER IRON PIPE SURVEY MONUMENT SET WITH ALUMINUM CAP STAMPED "ILS 2006 2207"
 - EXISTING IRON PIPE/PIN SURVEY MONUMENT FOUND
 - ⊠ EXISTING CONCRETE MARKER FOUND
 - () RECORD MEASUREMENT AND/OR DATA
 - WC WITNESS CORNER
 - └┘ DENOTES 90 DEGREE ANGLE
 - — — EXISTING DITCH CENTERLINE
 - — — EXISTING UTILITY EASEMENT LINE
 - — — EXISTING CENTERLINE
 - — — EXISTING BUILDING SETBACK LINE
 - — — EXISTING RIGHT-OF-WAY
 - — — PROPOSED RIGHT-OF-WAY
 - — — PROPOSED UTILITY EASEMENT LINE
 - — — PROPOSED SANITARY EASEMENT LINE
 - — — PROPOSED STREET CENTERLINE
 - — — PROPOSED EMERGENCY DRAINAGE SWALE
 - — — TITLE LINE
 - — — EXISTING BUILDING LINE
 - — — EXISTING CULVERT
 - — — EXISTING OVERHEAD TELEPHONE LINE
 - — — EXISTING OVERHEAD ELECTRIC LINE
 - — — AC — VEHICULAR ACCESS CONTROL
 - — — LOT 17 PROPOSED LOT NUMBER
 - CR LOT WITHIN COUNTY CONSERVATION RECREATION (CR) ZONING DISTRICT
 - AG-2 LOT WITHIN COUNTY AGRICULTURE (AG-2) ZONING DISTRICT
 - ▲ EXISTING SIGN
 - EXISTING POLE/POST
 - BENCHMARK/DESIGNATION
 - TS#1 TRAVERSE STATION
 - EXISTING DECIDUOUS TREE/SIZE
 - EXISTING EVERGREEN TREE/SIZE
 - EXISTING "SOFT" SPOT ELEVATION
 - EXISTING "HARD" SPOT ELEVATION
 - EXISTING "HARD" SPOT ELEVATION AT MANHOLE RIM
 - ⊠ EXISTING GAS METER
 - ⊕ EXISTING PRIVATE WATER WELL
 - ⊠ EXISTING TELEPHONE PEDESTAL
 - ⊕ EXISTING UTILITY POLE/GUY WIRE/TRANSFORMER
 - ⊕ EXISTING GLOBE POLE LIGHT
 - ⊕ EXISTING STORM SEWER MANHOLE (OPEN LID)
 - ⊠ BERN'S, CLANCY AND ASSOCIATES MANHOLE DESIGNATION
 - 10"ST— EXISTING STORM SEWER LINE/SIZE (APPROXIMATE LOCATION)
 - ? DESTINATION OR DATA UNKNOWN
 - ⊕ EXISTING PRIVATE MAILBOX
 - ⊕ EXISTING SANITARY SEWAGE CLEANOUT
 - 700— EXISTING INDEX CONTOUR LINE
 - 698— EXISTING INTERMEDIATE CONTOUR LINE
 - — — EXISTING CULTIVATION LINE
 - — — EXISTING TREE LINE
 - ⊠ EXISTING ELECTRIC METER
 - (LOT 8) PRE-EXISTING LOT NUMBER OF COUNTRYSIDE SUBDIVISION PLAT BOOK "N" PAGE 106 RECORDED JUNE 11, 1962

SIGNED AND SEALED JUNE 10, 2013

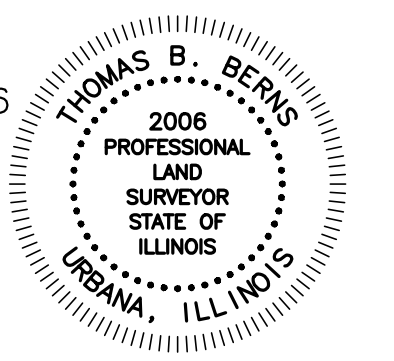
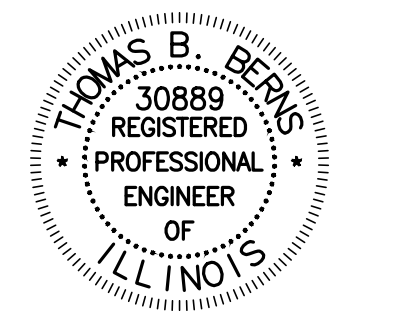

THOMAS B. BERN'S, P.E., L.S., PRESIDENT
 BERN'S, CLANCY AND ASSOCIATES, P.C.
 ILLINOIS PROFESSIONAL LAND SURVEYOR 2006
 LICENSE EXPIRATION: NOVEMBER 30, 2014
 ILLINOIS PROFESSIONAL ENGINEER 30889
 LICENSE EXPIRATION: NOVEMBER 30, 2013
 URBANA, CHAMPAIGN COUNTY, ILLINOIS
 ILLINOIS PROFESSIONAL DESIGN FIRM 2999
 LICENSE EXPIRATION: APRIL 30, 2015

PRELIMINARY PLAT
COUNTRYSIDE SECOND SUBDIVISION,
URBANA TOWNSHIP,
CHAMPAIGN COUNTY, ILLINOIS

J. U. L. I. E.
 NOTE: THE EXACT LOCATION OF ALL UTILITIES SHALL BE VERIFIED BY THE CONTRACTOR PRIOR TO CONSTRUCTION ACTIVITIES. FOR UTILITY LOCATIONS CALL: J.U.L.I.E. (800) 892-0123
 © 2013 ALL RIGHTS RESERVED BERN'S, CLANCY AND ASSOCIATES, P.C.

OWNER / DEVELOPER:
 MARCUS HARRIS
 1780 CR 1650 NORTH
 URBANA IL 61802
 (217) 621-3971

ATTORNEY:
 JASON BARICKMAN
 MEYER CAPEL, A PROFESSIONAL CORPORATION
 306 WEST CHURCH ST
 CHAMPAIGN IL 61820

BCA BERN'S, CLANCY AND ASSOCIATES
 ENGINEERS • SURVEYORS • PLANNERS
 405 EAST MAIN STREET - POST OFFICE BOX 755
 URBANA, ILLINOIS 61803-0755
 PHONE: (217) 384-1144 - FAX: (217) 384-3355

JOB: 6598 DATE: 061013 SHEET 1 OF 3
 FILE: 6598-1PP.DWG

GENERAL NOTES

ALL MEASUREMENTS ARE IN FEET AND DECIMAL PARTS THEREOF, UNLESS NOTED OTHERWISE.

SEE MUNICIPAL/COUNTY ORDINANCES AND REGULATIONS FOR ZONING, SETBACK AND BUILDING STANDARD REQUIREMENTS.

ALL ELEVATIONS SHOWN ARE BASED UPON THE NORTH AMERICAN VERTICAL DATUM OF 1988 (MEAN SEA LEVEL DATUM) AS ESTABLISHED AND PUBLISHED BY THE UNITED STATES NATIONAL GEODETIC SURVEY.

NAMES OF ANY APPARENT ADJOINING LAND OWNERS SHOWN WERE OBTAINED FROM THE COUNTY ASSESSOR'S RECORDS, CHAMPAIGN COUNTY, ILLINOIS.

COORDINATES AND BEARINGS SHOWN ARE BASED UPON THE ILLINOIS STATE PLANE COORDINATE SYSTEM, EAST ZONE, NAD 83 (CORS 96).

DETAILS NOT DRAWN TO SCALE.

SEE MONUMENT RECORDS ON FILE WITH THE COUNTY RECORDER'S OFFICE FOR DETAILS OF SECTION CORNERS USED IN THIS SURVEY.

SUBJECT SITE IS REPORTEDLY LOCATED WITHIN THE SALINE BRANCH DRAINAGE DISTRICT.

BASED UPON MY REVIEW OF THE FEDERAL EMERGENCY MANAGEMENT AGENCY FLOOD INSURANCE RATE MAP, PANEL 185 OF 300, COMMUNITY PANEL NUMBER 170894 0185 B WITH AN EFFECTIVE DATE OF MARCH 1, 1984, THE PROPERTY SURVEYED IS REPORTEDLY WHOLLY LOCATED WITHIN ZONE C (AREAS OF MINIMAL FLOODING)

PUBLIC WATER AND SANITARY SEWER ARE NOT AVAILABLE. PROPOSED LOTS WILL BE SERVED BY INDIVIDUAL PRIVATE WELLS AND SEWAGE SEPTIC SYSTEMS

A SPECIAL SERVICE AREA WILL BE CREATED TO FINANCE CONSTRUCTION OF A SANITARY SEWER TO SERVE COUNTRY SIDE SECOND SUBDIVISION WHEN A PUBLIC SEWER IS EXTENDED TO A POINT WITHIN 200 FEET OF COUNTRY SIDE SECOND SUBDIVISION.

THE DRIVEWAY FOR LOT 11 AND FOR LOT 14 SHALL BE LOCATED ALONG THE PROPOSED STREET A MINIMUM OF 60 FEET EASTERLY OF THE WESTERN LINE OF SAID LOTS. NO DRIVEWAY ACCESS TO COTTONWOOD ROAD SHALL BE ALLOWED.

THE DRIVEWAY FOR LOT 15 SHALL BE LOCATED WITHIN 100 FEET OF THE EASTERLY LOT LINE OF LOT 5. NO OTHER DRIVEWAY ACCESS TO ANTHONY DRIVE OR TO COTTONWOOD ROAD SHALL BE ALLOWED.

THE DRIVEWAY FOR LOT 17 SHALL BE LOCATED WITHIN 75 FEET OF THE EASTERLY LOT LINE OF LOT 17. NO OTHER DRIVEWAY ACCESS TO ANTHONY DRIVE SHALL BE ALLOWED.

THE DEVELOPER(S) OR SUBSEQUENT OWNER(S) OF THE PROPERTY AFFECTED WILL CONSTRUCT THE SIDEWALK ALONG COTTONWOOD ROAD AND/OR ANTHONY DRIVE AT THE DEVELOPER(S) OR SUBSEQUENT OWNER(S) EXPENSE WITHIN SIX (6) MONTHS OF A WRITTEN REQUEST BY THE URBANA CITY ENGINEER OR HIS REPRESENTATIVE TO DO SO OR THE CITY OF URBANA WILL CONSTRUCT AND INVOICE THE THEN OWNER(S) AND/OR DEVELOPER(S) AS APPLICABLE.

OWNER'S AND ENGINEER'S STATEMENT

TO THE BEST OF OUR KNOWLEDGE AND BELIEF, THE DRAINAGE OF SURFACE WATERS WILL NOT BE CHANGED BY THE DEVELOPMENT OF "COUNTRYSIDE SECOND SUBDIVISION, URBANA TOWNSHIP, CHAMPAIGN COUNTY, ILLINOIS" OR ANY PART THEREOF, OR IF SUCH SURFACE WATER DRAINAGE WILL BE CHANGED THAT REASONABLE PROVISION HAS BEEN MADE FOR THE COLLECTION AND DIVERSION OF SURFACE WATERS INTO PUBLIC AREAS, OR DRAINS WHICH THE SUBDIVIDER HAS THE RIGHT TO USE, AND THAT SUCH SURFACE WATERS WILL BE PLANNED FOR IN ACCORDANCE WITH GENERALLY ACCEPTED ENGINEERING PRACTICES SO AS TO REDUCE THE LIKELIHOOD OF DAMAGE TO THE ADJOINING PROPERTY BECAUSE OF CONSTRUCTION OF "COUNTRYSIDE SECOND SUBDIVISION, URBANA TOWNSHIP, CHAMPAIGN COUNTY, ILLINOIS"

THOMAS B. BERNS P.E., L.S., PRESIDENT
 BERNS, CLANCY AND ASSOCIATES, P.C.
 ILLINOIS PROFESSIONAL ENGINEER 30889
 URBANA, CHAMPAIGN COUNTY, ILLINOIS
 DATE OF LICENSE EXPIRATIONS: NOVEMBER 30, 2013

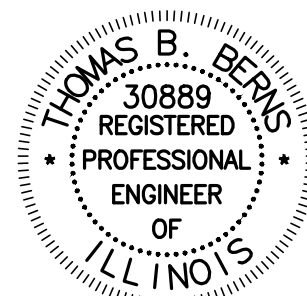

MARCUS HARRIS

J. U. L. I. E.
 NOTE: THE EXACT LOCATION OF ALL UTILITIES SHALL BE VERIFIED BY THE CONTRACTOR PRIOR TO CONSTRUCTION ACTIVITIES. FOR UTILITY LOCATIONS CALL: J.U.L.I.E. (800) 892-0123

© 2013 ALL RIGHTS RESERVED
 BERNS, CLANCY AND ASSOCIATES, P.C.

LEGAL DESCRIPTION

LOTS 2, 3, 4, 5, 6, 7, AND 8 OF COUNTRY SIDE SUBDIVISION, CHAMPAIGN COUNTY, ILLINOIS, AS PER PLAT RECORDED IN PLAT BOOK "N" AT PAGE 106.

AND ALSO:

A PART OF THE SOUTHWEST QUARTER OF THE NORTHWEST QUARTER OF SECTION 12, TOWNSHIP 19 NORTH, RANGE 9 EAST OF THE THIRD PRINCIPAL MERIDIAN, MORE PARTICULARLY DESCRIBED AS FOLLOWS:

COMMENCING AT THE SOUTHEAST CORNER OF LOT 1 OF SAID COUNTRY SIDE SUBDIVISION AND RUNNING THENCE SOUTH 90 DEGREES EAST 316.75 FEET, THENCE SOUTH TO THE NORTHEAST CORNER OF LOT 8 OF SAID SUBDIVISION, THENCE WEST ALONG THE NORTH LINE OF SAID LOT 8 TO THE NORTHWEST CORNER OF SAID LOT 8, THENCE SOUTH ALONG THE WEST LINE OF SAID LOT 8 TO THE POINT OF INTERSECTION WITH THE NORTH LINE OF THE PUBLIC ROAD, THENCE WEST ALONG THE NORTH LINE OF SAID ROAD TO THE POINT OF INTERSECTION WITH THE EAST LINE OF LOT 7 OF SAID SUBDIVISION, THENCE NORTH ALONG THE EAST LINE OF SAID LOT 7 TO THE NORTHEAST CORNER THEREOF, THENCE WEST ALONG THE NORTH LINE OF SAID LOT 7 AND THE NORTH LINES OF LOTS 6 AND 5 OF SAID SUBDIVISION TO THE SOUTHEAST CORNER OF LOT 3 OF SAID SUBDIVISION, THENCE NORTH ALONG THE EAST LINE OF SAID LOT 3 TO THE NORTHEAST CORNER THEREOF, THENCE WEST ALONG THE NORTH LINE OF SAID LOT 3 TO THE POINT OF INTERSECTION WITH THE EAST LINE OF THE PUBLIC ROAD, THENCE NORTH ALONG THE EAST LINE OF THE PUBLIC ROAD TO THE POINT OF INTERSECTION WITH THE SOUTH LINE OF LOT 2 OF SAID SUBDIVISION, THENCE EAST ALONG THE SOUTH LINE OF SAID LOT 2 TO THE SOUTHEAST CORNER THEREOF, THENCE NORTH ALONG THE EAST LINE OF SAID LOT 2 TO THE SOUTH LINE OF LOT 1 OF SAID SUBDIVISION, THENCE EAST ALONG THE SOUTH LINE OF SAID LOT 1 TO THE POINT OF BEGINNING, ALL SITUATED IN CHAMPAIGN COUNTY, ILLINOIS.

THE ABOVE DESCRIBED NET TRACT CONTAINS 8.38 ACRES, MORE OR LESS, ALL SITUATED IN URBANA TOWNSHIP, CHAMPAIGN COUNTY, ILLINOIS.

CHAMPAIGN COUNTY				BUILDING SETBACK			
ZONING	LOTS	MINIMUM LOT DIMENSION	MIN LOT AREA	FRONT ¹	FRONT ²	SIDE	REAR
CR (NORTHERN 200 FEET)	11	200 FEET	1.0 ACRE	85 FEET	40 FEET	15 FEET	25 FEET
	12	200 FEET	1.0 ACRE	-	40 FEET	15 FEET	25 FEET
AG2	13	100 FEET	30,000 SQ FT	-	40 FEET	10 FEET	20 FEET
	14	100 FEET	30,000 SQ FT	85 FEET	40 FEET	10 FEET	20 FEET
	15	100 FEET	30,000 SQ FT	VARIES	-	10 FEET	20 FEET
	16 & 17	100 FEET	30,000 SQ FT	55 FEET	-	10 FEET	20 FEET

¹ MINIMUM FRONT SETBACK ALONG COTTONWOOD ROAD IS 85 FEET FROM THE CENTERLINE. MINIMUM FRONT SETBACK ALONG ANTHONY DRIVE IS 55 FEET FROM THE CENTERLINE OR 25 FEET FROM THE RIGHT-OF-WAY LINE.

² FRONT SETBACK ALONG PROPOSED STREET IS 40 FEET FROM THE RIGHT-OF-WAY LINE.

BENCHMARKS (NAVD 1988)

BCA BENCHMARK 2828
 ELEVATION: 684.60 FT.

CHISELED SQUARE ON BRIDGE OVER THE SALINE BRANCH DRAINAGE DITCH, ¼ MILE NORTHERLY OF ANTHONY DRIVE, 13.2 FEET WESTERLY OF THE CENTERLINE OF COTTONWOOD DRIVE AND 50.4 FEET NORTHERLY OF THE CENTER OF THE BRIDGE, URBANA TOWNSHIP, CHAMPAIGN COUNTY, ILLINOIS.

BCA BENCHMARK 4388
 ELEVATION: 693.56 FT.

MAG NAIL IN SOUTHERLY FACE OF A UTILITY POLE 1.1 FEET ABOVE GROUND, 500 FEET FEET± NORTHERLY OF THE CENTERLINE OF ANTHONY DRIVE, 122 FEET NORTHWESTERLY OF AN OPEN GRATE STORM MANHOLE AND 69.0 FEET WESTERLY OF THE CENTERLINE OF COTTONWOOD DRIVE, URBANA TOWNSHIP, CHAMPAIGN COUNTY, ILLINOIS.

BCA BENCHMARK 4389
 ELEVATION: 693.75 FT.

MAG NAIL IN EASTERLY FACE OF A UTILITY POLE 0.9 FEET ABOVE GROUND 73.0 FEET NORTHERLY OF THE CENTERLINE OF ANTHONY DRIVE, 69.5 FEET WESTERLY OF THE CENTERLINE OF COTTONWOOD DRIVE AND 46.0 FEET NORTHWESTERLY OF AN OPEN GRATE STORM MANHOLE, URBANA TOWNSHIP, CHAMPAIGN COUNTY, ILLINOIS.

BCA BENCHMARK 4390
 ELEVATION: 697.53 FT.

"PK" NAIL IN WESTERLY FACE OF A UTILITY POLE 30.5 FEET NORTHERLY OF THE CENTERLINE OF ANTHONY DRIVE, 532 FEET EASTERLY OF THE CENTERLINE OF COTTONWOOD DRIVE AND 83.6 FEET SOUTHEASTERLY OF THE SOUTHEASTERN CORNER OF A BRICK HOUSE AND 26.5 FEET, URBANA TOWNSHIP, CHAMPAIGN COUNTY, ILLINOIS.

HORIZONTAL CONTROL (NAD 83 (CORS 96))

TRAVERSE STATION 1
 N: 1,258,588.66 FT.
 E: 1,037,241.10 FT.

½ INCH DIAMETER IRON PIPE WITH CAP "ILS 2006 2207" IN GRASS 27.5 FEET NORTHERLY OF THE CENTERLINE OF ANTHONY DRIVE AND 37.0 FEET WESTERLY OF THE CENTERLINE OF COTTONWOOD ROAD, URBANA TOWNSHIP, CHAMPAIGN COUNTY, ILLINOIS

TRAVERSE STATION 106
 N: 1,259,139.32 FT.
 E: 1,037,286.67 FT.

½ INCH DIAMETER REBAR 577 FEET NORTHERLY OF THE CENTERLINE OF ANTHONY DRIVE, 13.8 FEET EASTERLY OF THE CENTERLINE OF COTTONWOOD ROAD AND 40 FEET ± SOUTHERLY OF THE CENTERLINE OF A CRUSHED STONE DRIVEWAY, URBANA TOWNSHIP, CHAMPAIGN COUNTY, ILLINOIS.

UTILITIES NOTE

UTILITIES SHOWN ARE AS REPORTED TO US AND AS INDICATED ON EXISTING UTILITY BASE MAPS AND REFERENCE DATA PROVIDED TO US. NO ATTEMPT HAS BEEN MADE TO EXCAVATE, UNCOVER, EXPOSE OR ELECTRONICALLY LOCATE THESE FACILITIES TO FIELD CHECK THE EXISTENCE, SIZE, DEPTH, CONDITION, CAPACITY OR EXACT LOCATION OF THESE UTILITIES. FOR ADDITIONAL INFORMATION CONTACT:

GAS:

AMEREN ILLINOIS
 ATTN: STEVE ESTES
 1112 WEST ANTHONY DRIVE
 POST OFFICE 17070
 URBANA, IL 61801-7070

TELEPHONE:

AT&T (LOCAL)
 201 SOUTH NEIL STREET
 CHAMPAIGN, IL 61820
 PHONE: 217/398-7980
 FAX: 217/398-7991

ELECTRIC:

AMEREN ILLINOIS
 ATTN: STEVE ESTES
 1112 WEST ANTHONY DRIVE
 POST OFFICE 17070
 URBANA, IL 61801-7070

U.S. SPRINT CORPORATION
 ATTN: JAMES BURTON
 5600 NORTH RIVER ROAD,
 SUITE 300
 ROSEMONT, IL 60018
 PHONE: 847/737-1273
 FAX: 847/737-1377

TRANSPORTATION:

ILLINOIS DEPARTMENT OF TRANSPORTATION DISTRICT 5
 ATTN: KEN HACKNEY
 13473 ILL HIGHWAY 133
 POST OFFICE BOX 610
 PARIS, IL 61944-0610
 PHONE: 217/465-4181
 FAX: 217/465-5732

MCI TELECOMMUNICATIONS
 2921 GREENBRIAR DRIVE
 SUITE A
 SPRINGFIELD, IL 62704
 PHONE: 217/546-9410

CHAMPAIGN COUNTY HIGHWAY DEPARTMENT
 ATTN: DAN LYBARGER
 1605 EAST MAIN STREET
 URBANA, IL 61802
 PHONE: 217/384-3800
 FAX: 217/328-5148

McLEOD USA
 ATTN: JEFF TAYLOR
 30486 E 400 NORTH ROAD
 STRAWN, IL 61775
 PHONE: 309/838-0788

URBANA TOWNSHIP HIGHWAY COMMISSIONER
 ATTN: JIM PRATHER
 2312 PERKINS ROAD
 URBANA, IL 61802
 PHONE: 217/344-7361
 FAX: 217/367-3555

CONXXUS
 330 WEST OTTAWA STREET
 PAXTON, IL 60957
 PHONE: 217/379-2026
 FAX: 217/379-3361

ONE - CALL SYSTEM:

J.U.L.I.E.
 PHONE: 800/892-0123

CABLE TELEVISION:

COMCAST
 ATTN: ROBERT VALENTINE
 303 FAIRLAWN DRIVE
 URBANA, ILLINOIS 61801
 PHONE: 217/384-8031
 FAX: 217/384-2021

MANHOLE DATA

STORM MANHOLE 1
 RIM ELEVATION: 689.87 FT.
 INV. 6 INCH CONC. NW: 687.09 FT.
 INV. 6 INCH CONC. S: 687.22 FT.

STORM MANHOLE 2
 RIM ELEVATION: 690.11 FT.
 INV. 15 INCH CONC. NW: 685.41 FT.
 INV. 15 INCH CONC. S: 685.41 FT.

STORM MANHOLE 3
 RIM ELEVATION: 689.33 FT.
 INV. 15 INCH CONC. NW: 683.21 FT.
 INV. 15 INCH CONC. S: 683.30 FT.

APPROVED BY: THE URBANA PLAN COMMISSION OF THE CITY OF URBANA, ILLINOIS.

DATE: _____ CHAIRPERSON: _____

APPROVED BY: THE CITY COUNCIL OF THE CITY OF URBANA, ILLINOIS, IN ACCORDANCE WITH ORDINANCE NO. _____

DATE: _____ BY _____ MAYOR

ATTEST: _____, CITY CLERK

PRELIMINARY PLAT

**COUNTRYSIDE SECOND SUBDIVISION,
 URBANA TOWNSHIP,
 CHAMPAIGN COUNTY, ILLINOIS**

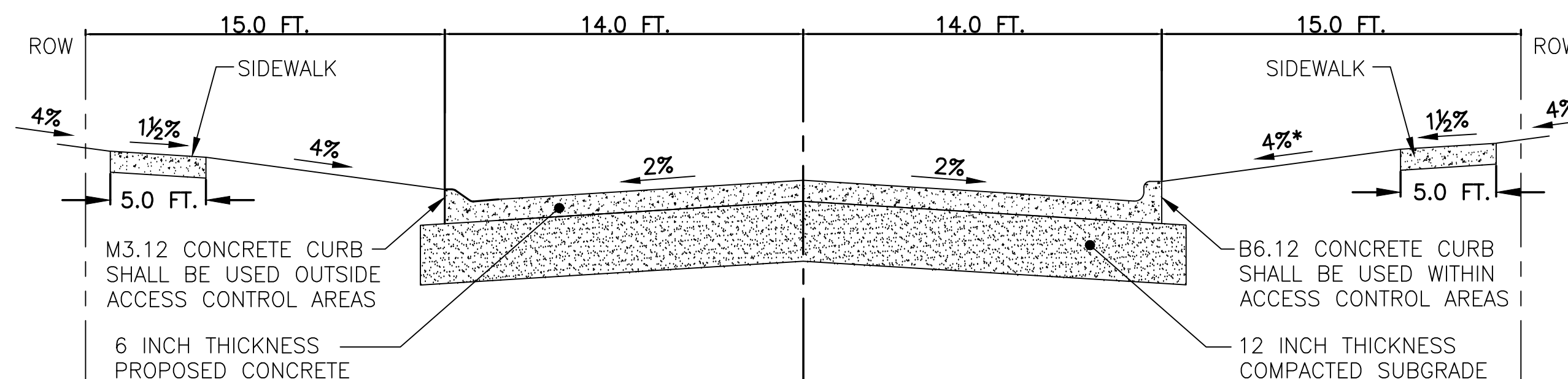

TYPICAL PROPOSED STREET CROSS SECTION



BERNS, CLANCY AND ASSOCIATES
 ENGINEERS • SURVEYORS • PLANNERS
 405 EAST MAIN STREET - POST OFFICE BOX 755
 URBANA, ILLINOIS 61803-0755
 PHONE: (217) 384-1144 - FAX: (217) 384-3355

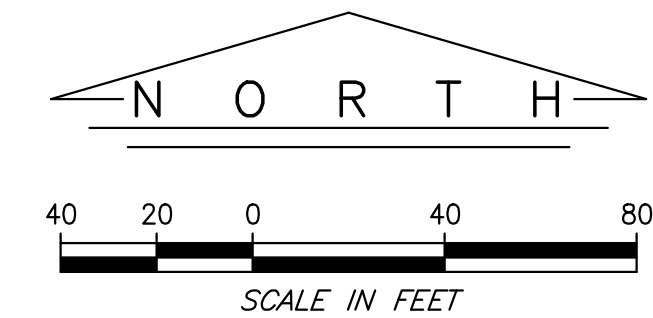
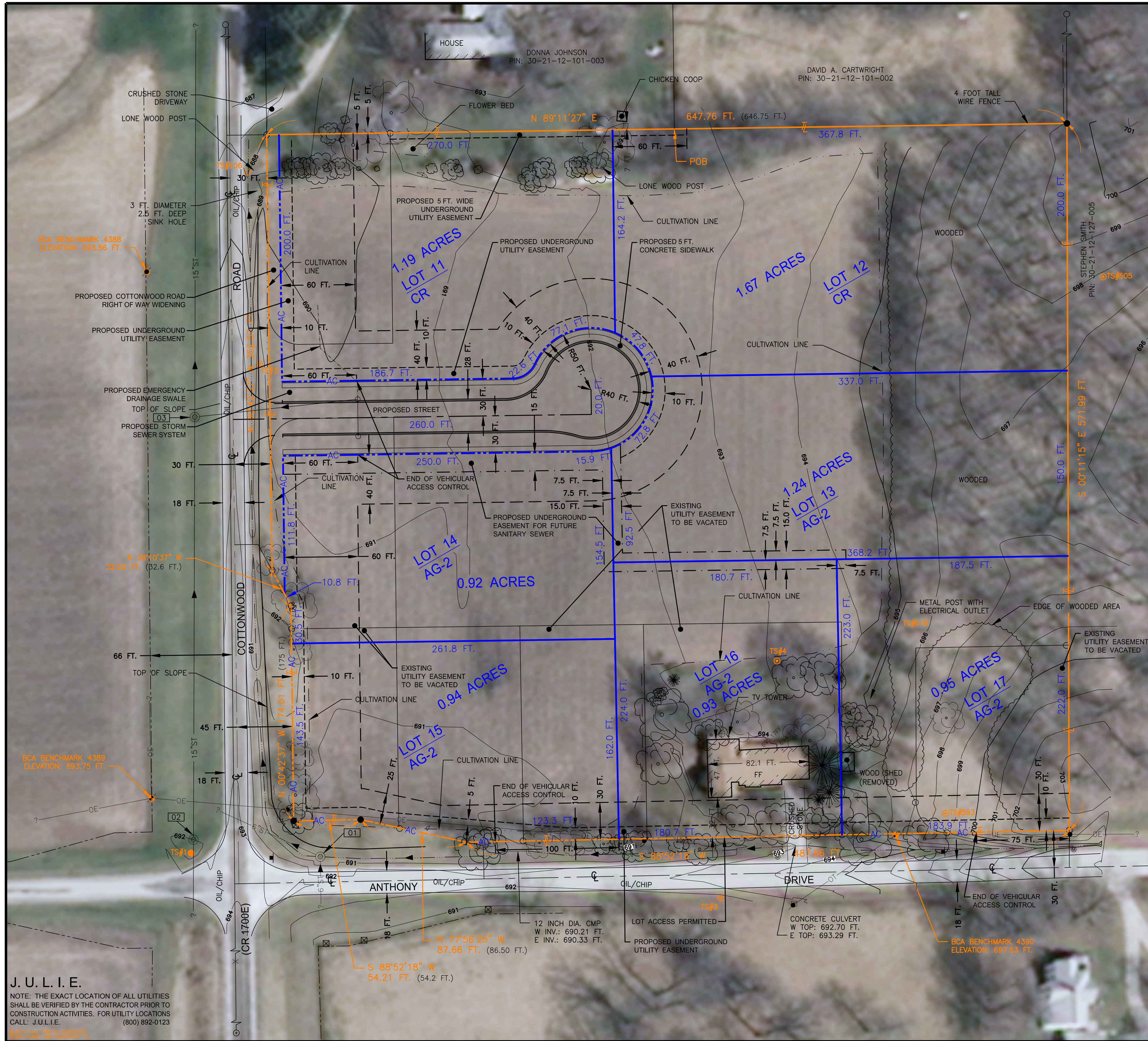

AERIAL PHOTOGRAPHY FROM
CHAMPAIGN COUNTY
ORTHOGRAPHY
DATED APRIL 2008

LEGEND

- 30 INCH LONG, 1/2 INCH DIAMETER IRON PIPE SURVEY MONUMENT SET WITH ALUMINUM CAP STAMPED "ILS 2006 2207"
- EXISTING IRON PIPE/PIN SURVEY MONUMENT FOUND
- ⊠ EXISTING CONCRETE MARKER FOUND
- () RECORD MEASUREMENT AND/OR DATA
- WC WITNESS CORNER
- ⊥ DENOTES 90 DEGREE ANGLE
- EXISTING DITCH CENTERLINE
- *— EXISTING FENCE LINE
- - - EXISTING UTILITY EASEMENT LINE
- - - EXISTING CENTERLINE
- - - EXISTING BUILDING SETBACK LINE
- - - EXISTING RIGHT-OF-WAY
- - - EXISTING UTILITY EASEMENT LINE
- - - EXISTING SANITARY EASEMENT LINE
- - - EXISTING STREET CENTERLINE
- - - EXISTING EMERGENCY DRAINAGE SWALE
- AC — VEHICULAR ACCESS CONTROL
- EXISTING BUILDING LINE
- EXISTING CULVERT
- OT — EXISTING OVERHEAD TELEPHONE LINE
- OE — EXISTING OVERHEAD ELECTRIC LINE
- EXISTING CULTIVATION LINE
- EXISTING TREE LINE
- ▲ EXISTING ELECTRIC METER
- EXISTING SIGN
- EXISTING POLE/POST
- BENCHMARK/DESIGNATION
- TS#1 TRAVERSE STATION
- ⊙ EXISTING DECIDUOUS TREE/SIZE
- ⊙ EXISTING EVERGREEN TREE/SIZE
- ⊙ EXISTING "SOFT" SPOT ELEVATION
- ⊙ EXISTING "HARD" SPOT ELEVATION
- ⊙ EXISTING "HARD" SPOT ELEVATION AT MANHOLE RIM
- ⊙ EXISTING GAS METER
- ⊙ EXISTING PRIVATE WATER WELL
- ⊙ EXISTING TELEPHONE PEDESTAL
- ⊙ EXISTING UTILITY POLE/GUY WIRE/TRANSFORMER
- ⊙ EXISTING GLOBE POLE LIGHT
- ⊙ EXISTING STORM SEWER MANHOLE (OPEN LID)
- ⊙ BERN'S, CLANCY AND ASSOCIATES MANHOLE DESIGNATION
- 10"ST- EXISTING STORM SEWER LINE/SIZE (APPROXIMATE LOCATION)
- ? DESTINATION OR DATA UNKNOWN
- ⊙ EXISTING PRIVATE MAILBOX
- ⊙ EXISTING SANITARY SEWAGE CLEANOUT
- 700- EXISTING INDEX CONTOUR LINE
- 698- EXISTING INTERMEDIATE CONTOUR LINE
- - - EXISTING CULTIVATION LINE
- EXISTING ELECTRIC METER

LOT 17 PROPOSED LOT NUMBER

CR LOT WITHIN COUNTY CONSERVATION RECREATION (CR) ZONING DISTRICT
AG-2 LOT WITHIN COUNTY AGRICULTURE (AG-2) ZONING DISTRICT

(LOT 8) PRE-EXISTING LOT NUMBER OF COUNTRYSIDE SUBDIVISION PLAT BOOK "N" PAGE 106 RECORDED JUNE 11, 1962

PRELIMINARY PLAT
COUNTRYSIDE SECOND SUBDIVISION,
URBANA TOWNSHIP,
CHAMPAIGN COUNTY, ILLINOIS



BERN'S, CLANCY AND ASSOCIATES
ENGINEERS • SURVEYORS • PLANNERS
405 EAST MAIN STREET - POST OFFICE BOX 755
URBANA, ILLINOIS 61803-0755
PHONE: (217) 384-1144 - FAX: (217) 384-3355

J. U. L. I. E.
NOTE: THE EXACT LOCATION OF ALL UTILITIES SHALL BE VERIFIED BY THE CONTRACTOR PRIOR TO CONSTRUCTION ACTIVITIES. FOR UTILITY LOCATIONS CALL: J.U.L.I.E. (800) 892-0123
© 2013 ALL RIGHTS RESERVED
BNAI, LINDA, AND ASSOCIATES, P.C.

JOB: 6598 DATE: 061013 SHEET 3 OF 3
FILE: 6598-1PP.DWG

I, THOMAS B. BERNS, ILLINOIS PROFESSIONAL LAND SURVEYOR 2207, IN ACCORDANCE WITH PAB7-0705 (THE PLAT ACT) DO HEREBY DESIGNATE THE CITY OF URBANA AS THE AGENT WHO MAY RECORD "COUNTRY SIDE SECOND SUBDIVISION, URBANA TOWNSHIP, CHAMPAIGN COUNTY, ILLINOIS". A TRUE COPY OF WHICH HAS BEEN RETAINED BY ME TO ASSURE NO CHANGES HAVE BEEN MADE TO SAID PLAT.

RETURN TO: BERNS, CLANCY AND ASSOCIATES, P.C.
405 EAST MAIN STREET
URBANA, ILLINOIS 61802

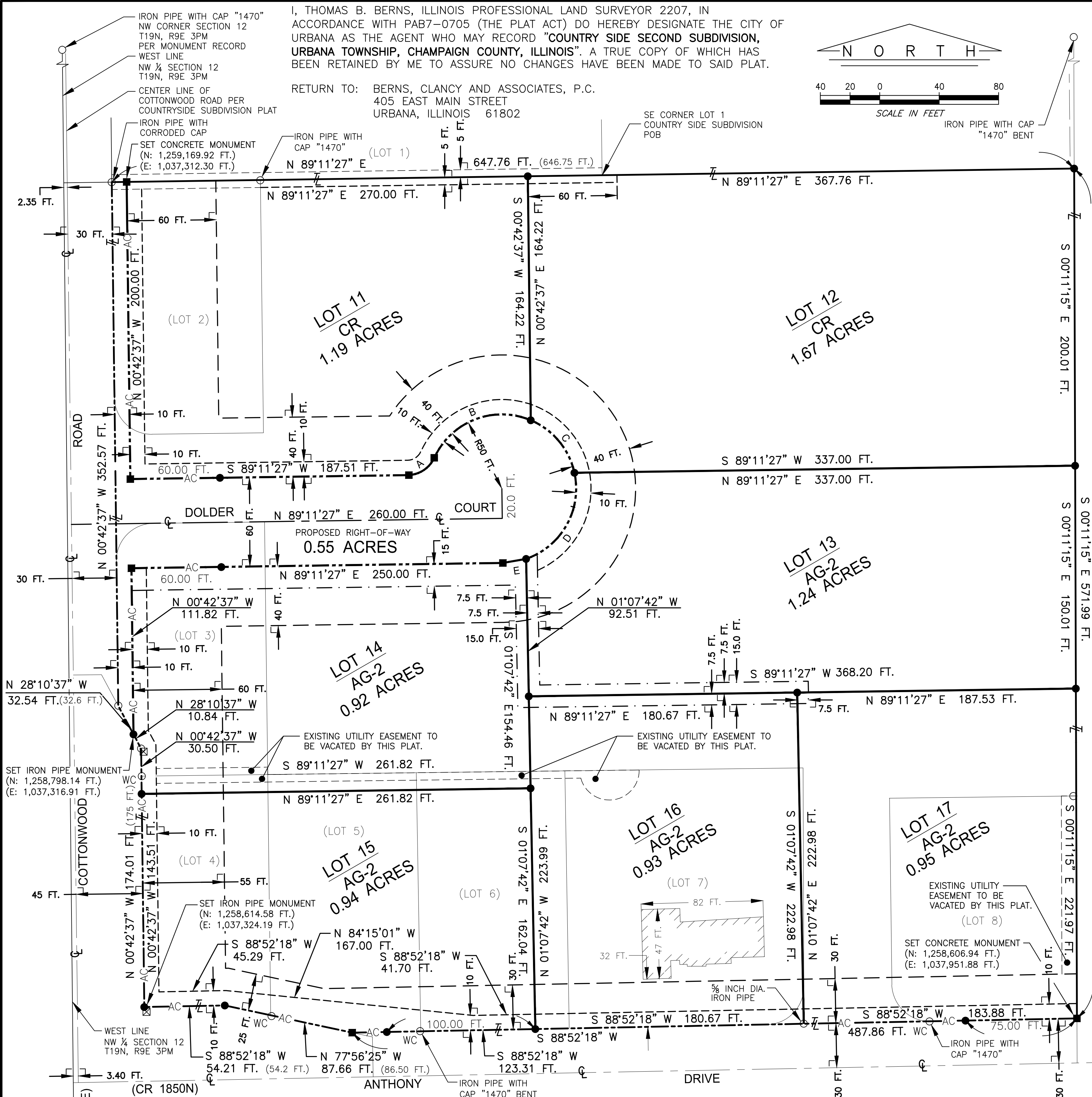
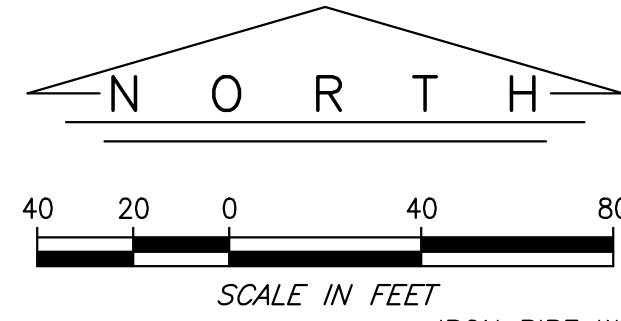

CURVE DATA				
ARC SECTION	ARC LENGTH	RADIUS	CHORD LENGTH	CHORD BEARING
A	22.75 FT.	20.00 FT.	20.70 FT.	S 55°41'03" W
B	77.09 FT.	50.00 FT.	69.68 FT.	S 68°44'22" W
C	47.77 FT.	50.00 FT.	45.98 FT.	N 39°43'03" W
D	72.70 FT.	50.00 FT.	66.46 FT.	N 29°18'22" E
E	15.91 FT.	50.00 FT.	15.89 FT.	N 80°06'14" E

RIGHT-OF-WAY:

THE RIGHT-OF-WAY DEPICTED IS HEREBY DEDICATED AND RESERVED TO URBANA TOWNSHIP, ILLINOIS, OR TO THE GENERAL PUBLIC UNTIL THE SUBDIVISION IS ANNEXED INTO THE CITY OF URBANA.

SIDEWALK DEFERRAL:

THE DEVELOPER(S) OR SUBSEQUENT OWNER(S) OF THE PROPERTY AFFECTED WILL CONSTRUCT THE SIDEWALK ALONG COTTONWOOD ROAD AND ANTHONY DRIVE AT THE DEVELOPER(S) OR SUBSEQUENT OWNER(S) EXPENSE WITHIN SIX (6) MONTHS OF A WRITTEN REQUEST BY THE URBANA CITY ENGINEER OR HIS REPRESENTATIVE TO DO SO OR THE CITY OF URBANA WILL CONSTRUCT AND INVOICE THE THEN OWNER(S) AND/OR DEVELOPER(S) AS APPLICABLE.

PUBLIC SANITARY SEWER SERVICE:

IT IS PROVIDED, AGREED AND COVENANTED THAT WITHIN SIX MONTHS OF A PUBLIC SANITARY SEWER SYSTEM BEING AVAILABLE TO THE LOTS IN THIS SUBDIVISION THAT ALL BUILDINGS REQUIRING SANITARY SEWER SERVICE SHALL BE CONNECTED TO SAID PUBLIC SANITARY SEWER SYSTEM. THE LOT OWNER SHALL BE RESPONSIBLE FOR CONSTRUCTION AND INSTALLATION OF SEWER CONNECTION AND SERVICE LINE AND PAYMENT OF ANY FEES. UNTIL A PUBLIC SANITARY SEWER SYSTEM IS AVAILABLE, THE LOT SHALL HAVE A PRIVATE ON-SITE SEWAGE DISPOSAL SYSTEM IN ACCORDANCE WITH ALL APPLICABLE REGULATIONS.

PUBLIC WATER SERVICE:

IT IS FURTHER PROVIDED, AGREED AND COVENANTED THAT WITHIN SIX MONTHS OF A PUBLIC WATER SYSTEM BEING AVAILABLE TO A LOT IN THIS SUBDIVISION, THAT ALL BUILDINGS REQUIRING WATER SERVICE SHALL BE CONNECTED TO SAID PUBLIC WATER SYSTEM. EACH LOT OWNER SHALL BE RESPONSIBLE FOR CONSTRUCTION AND INSTALLATION OF THE WATER CONNECTION AND SERVICE LINE AND PAYMENT OF ANY FEES. UNTIL A PUBLIC WATER SYSTEM IS AVAILABLE, EACH LOT SHALL HAVE A PRIVATE ON-SITE WATER SYSTEM IN ACCORDANCE WITH ALL APPLICABLE REGULATIONS.

LEGEND:

- CONCRETE SURVEY MONUMENT/30 INCH LONG, 1/2 INCH DIAMETER IRON PIPE SURVEY MONUMENT SET WITH ALUMINUM CAP STAMPED "ILS 2006 2207"
- 30 INCH LONG, 1/2 INCH DIAMETER IRON PIPE SURVEY MONUMENT SET WITH ALUMINUM CAP STAMPED "ILS 2006 2207"
- EXISTING IRON PIPE/PIN SURVEY MONUMENT FOUND
- ⊠ EXISTING CONCRETE MARKER FOUND
- () RECORD MEASUREMENT AND/OR DATA
- ⊥ DENOTES 90 DEGREE ANGLE
- WC WITNESS CORNER
- EXISTING UTILITY EASEMENT LINE
- EXISTING CENTERLINE
- PROPOSED RIGHT-OF-WAY
- PROPOSED BUILDING SETBACK LINE
- PROPOSED UTILITY EASEMENT LINE
- PROPOSED SANITARY EASEMENT LINE
- PROPOSED STREET CENTERLINE
- TITLE LINE
- EXISTING LOT LINE
- EXISTING BUILDING LINE
- (LOT 8) PRE-EXISTING LOT NUMBER OF COUNTRYSIDE SUBDIVISION PLAT BOOK "N" PAGE 106 RECORDED JUNE 11, 1962
- AC VEHICULAR ACCESS CONTROL
- LOT 17 PROPOSED LOT NUMBER
- CR LOT WITHIN COUNTY CONSERVATION RECREATION (CR) ZONING DISTRICT
- AG-2 LOT WITHIN COUNTY AGRICULTURE (AG-2) ZONING DISTRICT

APPROVED BY:

URBANA PLAN COMMISSION OF THE CITY OF URBANA

CHAIRPERSON _____ DATE

APPROVED BY:

CITY COUNCIL OF THE CITY OF URBANA, ILLINOIS, IN ACCORDANCE WITH ORDINANCE NO. _____

MAYOR _____ DATE

ATTEST: _____ CITY CLERK _____ DATE

APPROVED BY:

URBANA TOWNSHIP ROAD DISTRICT COMMISSIONER _____ DATE

FINAL PLAT

**COUNTRY SIDE
SECOND SUBDIVISION,
URBANA TOWNSHIP,
CHAMPAIGN COUNTY, ILLINOIS**



BERNS, CLANCY AND ASSOCIATES
ENGINEERS • SURVEYORS • PLANNERS
405 EAST MAIN STREET - POST OFFICE BOX 755
URBANA, ILLINOIS 61803-0755
PHONE: (217) 384-1144 - FAX: (217) 384-3355

© 2013 ALL RIGHTS RESERVED.
BERNS, CLANCY AND ASSOCIATES, P.C.

GENERAL NOTES

ALL MEASUREMENTS ARE IN FEET AND DECIMAL PARTS THEREOF, UNLESS NOTED OTHERWISE.

SEE CHAMPAIGN COUNTY ORDINANCES AND REGULATIONS FOR ZONING, SETBACK AND BUILDING STANDARD REQUIREMENTS.

COORDINATES AND BEARINGS SHOWN ARE BASED UPON THE ILLINOIS STATE PLANE COORDINATE SYSTEM, EAST ZONE, NAD 83 (1986) AS REFERENCED FROM CITY OF URBANA HORIZONTAL CONTROL STATIONS 74 AND 78. COORDINATES SHOWN ARE RECORD GRID COORDINATES.

SEE MONUMENT RECORDS ON FILE WITH THE COUNTY RECORDER'S OFFICE FOR DETAILS OF SECTION CORNERS USED IN THIS SURVEY.

THE NORTHERN 200 FEET OF SUBJECT SITE IS REPORTEDLY ZONED CR (CONSERVATION RECREATION). THE REMAINDER OF SUBJECT SITE IS REPORTEDLY ZONED AG-2 (AGRICULTURAL) BY CHAMPAIGN COUNTY PLANNING AND ZONING DEPARTMENT. BUILDING SETBACK SHALL BE 100 FEET FROM THE CENTER OF COTTONWOOD ROAD PAVEMENT. THE BUILDING SETBACK SHALL BE 60 FEET FROM THE CENTER OF ANTHONY DRIVE PAVEMENT BUT NOT LESS THAN 25 FEET FROM THE FRONT PROPERTY LINE. BUILDING SET BACK ALONG DOLDER COURT SHALL BE 40 FEET FROM THE FRONT PROPERTY LINE.

SUBJECT SITE IS REPORTEDLY LOCATED WITHIN THE SALINE BRANCH DRAINAGE DISTRICT.

PUBLIC WATER AND SANITARY SEWER ARE NOT AVAILABLE. PROPOSED LOTS WILL BE SERVED BY INDIVIDUAL PRIVATE WELLS AND INDIVIDUAL ON-SITE SEWAGE DISPOSAL SYSTEMS.

THE DRIVEWAY FOR LOT 11 AND FOR LOT 14 SHALL BE LOCATED ALONG DOLDER COURT A MINIMUM OF 60 FEET EASTERLY OF THE WESTERN LINE OF SAID LOTS. NO DRIVEWAY ACCESS TO COTTONWOOD ROAD SHALL BE ALLOWED.

THE DRIVEWAY FOR LOT 15 SHALL BE LOCATED WITHIN 100 FEET OF THE EASTERLY LOT LINE OF LOT 15. NO OTHER DRIVEWAY ACCESS TO ANTHONY DRIVE OR TO COTTONWOOD ROAD SHALL BE ALLOWED.

THE DRIVEWAY FOR LOT 17 SHALL BE LOCATED WITHIN 75 FEET OF THE EASTERLY LOT LINE OF LOT 17. NO OTHER DRIVEWAY ACCESS TO ANTHONY DRIVE SHALL BE ALLOWED.

SANITARY SEWER NOTE: NOTICE SHOULD BE TAKEN OF THE SPECIAL COVENANT REGARDING CREATION OF A SPECIAL SERVICE AREA TO FINANCE SPECIAL SERVICES (THE PLANNING, DESIGN, EASEMENT OR RIGHT-OF-WAY ACQUISITION, IEPA PERMIT FEES, OTHER APPLICABLE CITY AND UCSD FEES, AND CONSTRUCTION OF SANITARY SEWERS) IN COUNTRY SIDE SECOND SUBDIVISION, WHICH SAID COVENANTS ARE HEREBY INCORPORATED IN THIS PLAT OF SUBDIVISION BY REFERENCE.

OWNER'S AND ENGINEER'S STATEMENT

TO THE BEST OF OUR KNOWLEDGE AND BELIEF, THE DRAINAGE OF SURFACE WATERS WILL NOT BE CHANGED BY THE DEVELOPMENT OF "COUNTRYSIDE SECOND SUBDIVISION, URBANA TOWNSHIP, CHAMPAIGN COUNTY, ILLINOIS" OR ANY PART THEREOF, OR IF SUCH SURFACE WATER DRAINAGE WILL BE CHANGED THAT REASONABLE PROVISION HAS BEEN MADE FOR THE COLLECTION AND DIVERSION OF SURFACE WATERS INTO PUBLIC AREAS, OR DRAINS WHICH THE SUBDIVIDER HAS THE RIGHT TO USE, AND THAT SUCH SURFACE WATERS WILL BE PLANNED FOR IN ACCORDANCE WITH GENERALLY ACCEPTED ENGINEERING PRACTICES SO AS TO REDUCE THE LIKELIHOOD OF DAMAGE TO THE ADJOINING PROPERTY BECAUSE OF CONSTRUCTION OF "COUNTRYSIDE SECOND SUBDIVISION, URBANA TOWNSHIP, CHAMPAIGN COUNTY, ILLINOIS"

THOMAS B. BERNS P.E., L.S., PRESIDENT
BERNS, CLANCY AND ASSOCIATES, P.C.
ILLINOIS PROFESSIONAL ENGINEER 30889
URBANA, CHAMPAIGN COUNTY, ILLINOIS
DATE OF LICENSE EXPIRATIONS: NOVEMBER 30, 2013

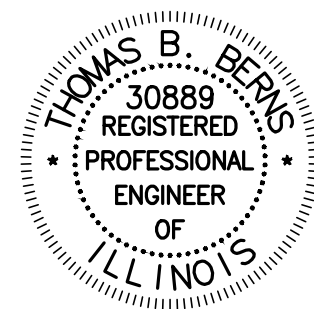

MR. MARCUS HARRIS

SURVEYOR'S / ENGINEER'S REPORT

I, THOMAS B. BERNS, ILLINOIS PROFESSIONAL LAND SURVEYOR 2006, ILLINOIS PROFESSIONAL ENGINEER 30889 AND VICE PRESIDENT OF BERNS, CLANCY AND ASSOCIATES, P.C., DO HEREBY STATE THAT AT THE REQUEST OF AND FOR THE EXCLUSIVE BENEFIT OF MR. MARCUS HARRIS, I PREPARED A BOUNDARY SURVEY AND TOPOGRAPHIC-SITE SURVEY ON THE GROUND TO THE NORMAL STANDARD OF CARE OF LAND SURVEYORS AND PROFESSIONAL ENGINEERS PRACTICING IN CHAMPAIGN COUNTY, ILLINOIS OF A PART OF THE NORTHWEST QUARTER OF SECTION 12, TOWNSHIP 19 NORTH, RANGE 9 EAST OF THE THIRD PRINCIPAL MERIDIAN, URBANA TOWNSHIP, CHAMPAIGN COUNTY, ILLINOIS, BEING MORE PARTICULARLY DESCRIBED AS SET FORTH IN CHICAGO TITLE INSURANCE COMPANY COMMITMENT NUMBER 1284-530002940-CH DATED MAY 14, 2012 AS FOLLOWS:

LOTS 2, 3, 4, 5, 6, 7, AND 8 OF COUNTRY SIDE SUBDIVISION, CHAMPAIGN COUNTY, ILLINOIS, AS PER PLAT RECORDED IN PLAT BOOK "N" AT PAGE 106.

AND ALSO:

A PART OF THE SOUTHWEST QUARTER OF THE NORTHWEST QUARTER OF SECTION 12, TOWNSHIP 19 NORTH, RANGE 9 EAST OF THE THIRD PRINCIPAL MERIDIAN, MORE PARTICULARLY DESCRIBED AS FOLLOWS:

COMMENCING AT THE SOUTHEAST CORNER OF LOT 1 OF SAID COUNTRY SIDE SUBDIVISION AND RUNNING THENCE SOUTH 90 DEGREES EAST 316.75 FEET, THENCE SOUTH TO THE NORTHEAST CORNER OF LOT 8 OF SAID SUBDIVISION, THENCE WEST ALONG THE NORTH LINE OF SAID LOT 8 TO THE NORTHWEST CORNER OF SAID LOT 8, THENCE SOUTH ALONG THE WEST LINE OF SAID LOT 8 TO THE POINT OF INTERSECTION WITH THE NORTH LINE OF THE PUBLIC ROAD, THENCE WEST ALONG THE NORTH LINE OF SAID ROAD TO THE POINT OF INTERSECTION WITH THE EAST LINE OF LOT 7 OF SAID SUBDIVISION, THENCE NORTH ALONG THE EAST LINE OF SAID LOT 7 TO THE NORTHEAST CORNER THEREOF, THENCE WEST ALONG THE NORTH LINE OF SAID LOT 7 AND THE NORTH LINES OF LOTS 6 AND 5 OF SAID SUBDIVISION TO THE SOUTHEAST CORNER OF LOT 3 OF SAID SUBDIVISION, THENCE NORTH ALONG THE EAST LINE OF SAID LOT 3 TO THE NORTHEAST CORNER THEREOF, THENCE WEST ALONG THE NORTH LINE OF SAID LOT 3 TO THE POINT OF INTERSECTION WITH THE EAST LINE OF THE PUBLIC ROAD, THENCE NORTH ALONG THE EAST LINE OF THE PUBLIC ROAD TO THE POINT OF INTERSECTION WITH THE SOUTH LINE OF LOT 2 OF SAID SUBDIVISION, THENCE EAST ALONG THE SOUTH LINE OF SAID LOT 2 TO THE SOUTHEAST CORNER THEREOF, THENCE NORTH ALONG THE EAST LINE OF SAID LOT 2 TO THE SOUTH LINE OF LOT 1 OF SAID SUBDIVISION, THENCE EAST ALONG THE SOUTH LINE OF SAID LOT 1 TO THE POINT OF BEGINNING, ALL SITUATED IN CHAMPAIGN COUNTY, ILLINOIS.

I FURTHER STATE THAT AS A RESULT OF THIS SURVEY, THE ABOVE DESCRIBED NET TRACT CONTAINS 8.38 ACRES, MORE OR LESS, ALL AS SHOWN ON THE ACCOMPANYING PLAT OF SURVEY, ALL SITUATED IN URBANA TOWNSHIP, CHAMPAIGN COUNTY, ILLINOIS.

I FURTHER STATE THAT BASED UPON MY REVIEW OF THE FEDERAL EMERGENCY MANAGEMENT AGENCY FLOOD INSURANCE RATE MAP, PANEL 185 OF 300, COMMUNITY PANEL NUMBER 170894 0185 B WITH AN EFFECTIVE DATE OF MARCH 1, 1984, THE PROPERTY SURVEYED IS REPORTEDLY WHOLLY LOCATED WITHIN ZONE C (AREAS OF MINIMAL FLOODING).

I FURTHER STATE THAT REFERENCE HAS BEEN MADE UPON SAID PLAT TO KNOWN AND PERMANENT SURVEY MONUMENTS FROM WHICH FUTURE SURVEYS MAY BE MADE AND THAT I PLACED SURVEY MONUMENTS AT EACH CORNER OF THE LOT AS SHOWN ON THE ACCOMPANYING PLAT AND THAT ALL OF THE DIMENSIONS ARE SHOWN IN FEET AND HUNDREDTHS OF FEET AND THAT THE EASEMENT LOCATIONS AND WIDTHS ARE AS INDICATED ON SAID PLAT.

I FURTHER STATE THAT NO INVESTIGATION CONCERNING ENVIRONMENTAL AND SUBSURFACE CONDITIONS, OR TO DETERMINE THE EXISTENCE OF UNDERGROUND OR OVERHEAD CONTAINERS OR FACILITIES WHICH MAY AFFECT THE USE OR DEVELOPMENT OF THIS PROPERTY WAS MADE AS A PART OF THIS SURVEY.

I FURTHER STATE THAT AS A PART OF THIS BOUNDARY SURVEY, EXCEPT AS MAY BE SPECIFICALLY NOTED ON THIS PLAT, I MADE NO INVESTIGATION CONCERNING ZONING OR LAND USE, NOR HAVE I MADE AN INDEPENDENT SEARCH OF THE RECORDS FOR EASEMENTS, ENCUMBRANCES, RESTRICTIVE COVENANTS, SUBDIVISION RESTRICTIONS, OWNERSHIP, TITLE EVIDENCE OR ANY OTHER FACTS WHICH AN ACCURATE AND CURRENT TITLE SEARCH MAY DISCLOSE FOR SUBJECT PROPERTY OR FOR ADJOINING PARCELS AS I RELIED UPON THE MATERIALS AND REPRESENTATIONS SUPPLIED BY THE OWNERS.

I FURTHER STATE THAT NO ATTEMPT HAS BEEN MADE AS A PART OF THIS BOUNDARY SURVEY TO OBTAIN DATA CONCERNING THE EXISTENCE, SIZE, DEPTH, CONDITION, CAPACITY, OR LOCATION OF ANY MUNICIPAL OR PUBLIC SERVICE FACILITY. FOR INFORMATION REGARDING THESE UTILITIES, PLEASE CONTACT THE APPROPRIATE AGENCIES.

I FURTHER STATE THAT THERE ARE NO APPARENT ABOVE GROUND ENCROACHMENTS EXCEPT AS SHOWN ON THE ACCOMPANYING PLAT OF SURVEY.

I FURTHER STATE THAT THE AREA COVERED BY THIS PLAT OF SURVEY IS NOT WITHIN THE CORPORATE LIMITS OF THE CITY OF URBANA, BUT IS LOCATED WITHIN THE ONE AND ONE-HALF MILE EXTRATERRITORIAL JURISDICTIONAL LIMITS OF THE CITY OF URBANA, CHAMPAIGN COUNTY, ILLINOIS.

I FURTHER STATE THAT NO PART OF THE AREA COVERED BY THIS PLAT OF SURVEY IS WITHIN 500 FEET OF A SURFACE DRAIN OR WATER COURSE SERVING A TRIBUTARY AREA OF 640 ACRES OR MORE.

I FURTHER STATE AT THE REQUEST OF THE OWNERS, THIS SUBDIVISION IS TO BE KNOWN AS "COUNTRY SIDE SECOND SUBDIVISION, URBANA TOWNSHIP, CHAMPAIGN COUNTY, ILLINOIS."

I FURTHER STATE THAT THIS PROFESSIONAL SERVICE CONFORMS TO THE CURRENT ILLINOIS MINIMUM STANDARDS FOR A BOUNDARY SURVEY.

SIGNED AND SEALED JUNE 10, 2013

THOMAS B. BERNS, P.E., L.S., PRESIDENT
BERNS, CLANCY AND ASSOCIATES, P.C.
ILLINOIS PROFESSIONAL LAND SURVEYOR 2006
LICENSE EXPIRATION: NOVEMBER 30, 2014
ILLINOIS PROFESSIONAL ENGINEER 30889
LICENSE EXPIRATION: NOVEMBER 30, 2013
URBANA, CHAMPAIGN COUNTY, ILLINOIS
ILLINOIS PROFESSIONAL DESIGN FIRM 2999
LICENSE EXPIRATION: APRIL 30, 2015

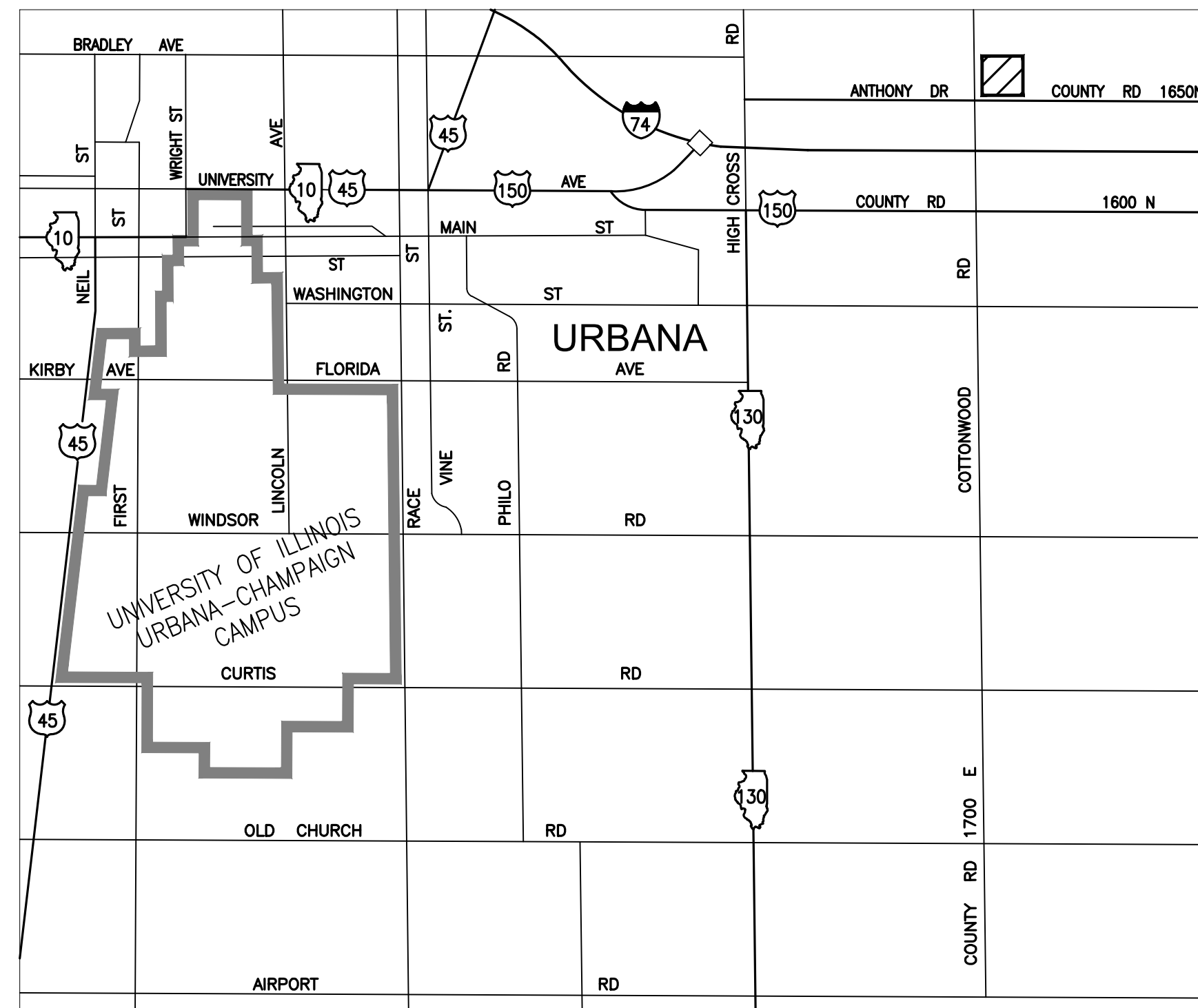
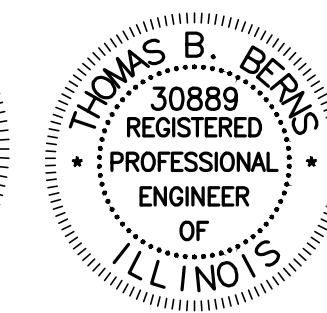
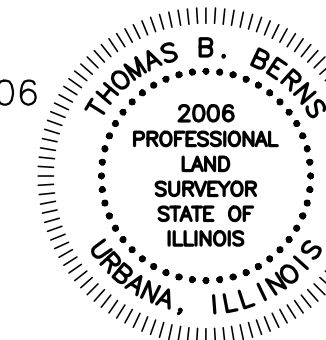

PROJECT LOCATION LOCATION MAP URBANA, ILLINOIS



FINAL PLAT

COUNTRY SIDE SECOND SUBDIVISION, URBANA TOWNSHIP, CHAMPAIGN COUNTY, ILLINOIS

BERNS, CLANCY AND ASSOCIATES ENGINEERS • SURVEYORS • PLANNERS
405 EAST MAIN STREET - POST OFFICE BOX 755
URBANA, ILLINOIS 61803-0755
PHONE: (217) 384-1144 - FAX: (217) 384-3355

